

KABELSCHLEPP

Innovative solutions

for the machine tool industry



CABLE CARRIER SYSTEMS
TRAXLINE® CABLES FOR MOTION
TOTALTRAX® COMPLETE TURN-KEY CARRIER SYSTEMS
GUIDEWAY PROTECTION SYSTEMS
CONVEYOR SYSTEMS

Innovative solutions

for the machine tool industry



kabelschlepp.de/machinetools/gb



Solutions from one source – from a global partner

The TSUBAKI Group comprises 40 manufacturing sites and 56 subsidiaries and offices in more than 70 countries worldwide. Tsubaki manufactures and supplies a comprehensive range of products from industrial drive & attachment chains, conveyor chains, sprockets, safety devices, shaft couplings & cam clutches to chain drive systems for the automotive industry. Within the TSUBAKI Group, TSUBAKI KABELSCHLEPP is responsible for worldwide product areas for cable carriers, TOTALTRAX® complete systems and TRAXLINE® cables. KABELSCHLEPP GmbH – Hünsborn produces guideway protection systems and conveyor systems.

The know-how of our product specialists in conjunction with the worldwide sales and service organization provide customers with qualified solutions for many different industries and applications. From consulting, planning and installation to on-site service – wherever you need us.

Additional information:

www.kabelschlepp.de
www.kabelschlepp.de/CAPS
www.tsubakimoto.com
www.tsubaki.eu



Brands for TSUBAKI KABELSCHLEPP GmbH are protected as national or international trademarks in the following countries: kabelschlepp.de/Trademarks



The Tsubaki Eco Link logo is used only on products that satisfy the standards for environmental friendliness set by the Tsubaki Group.

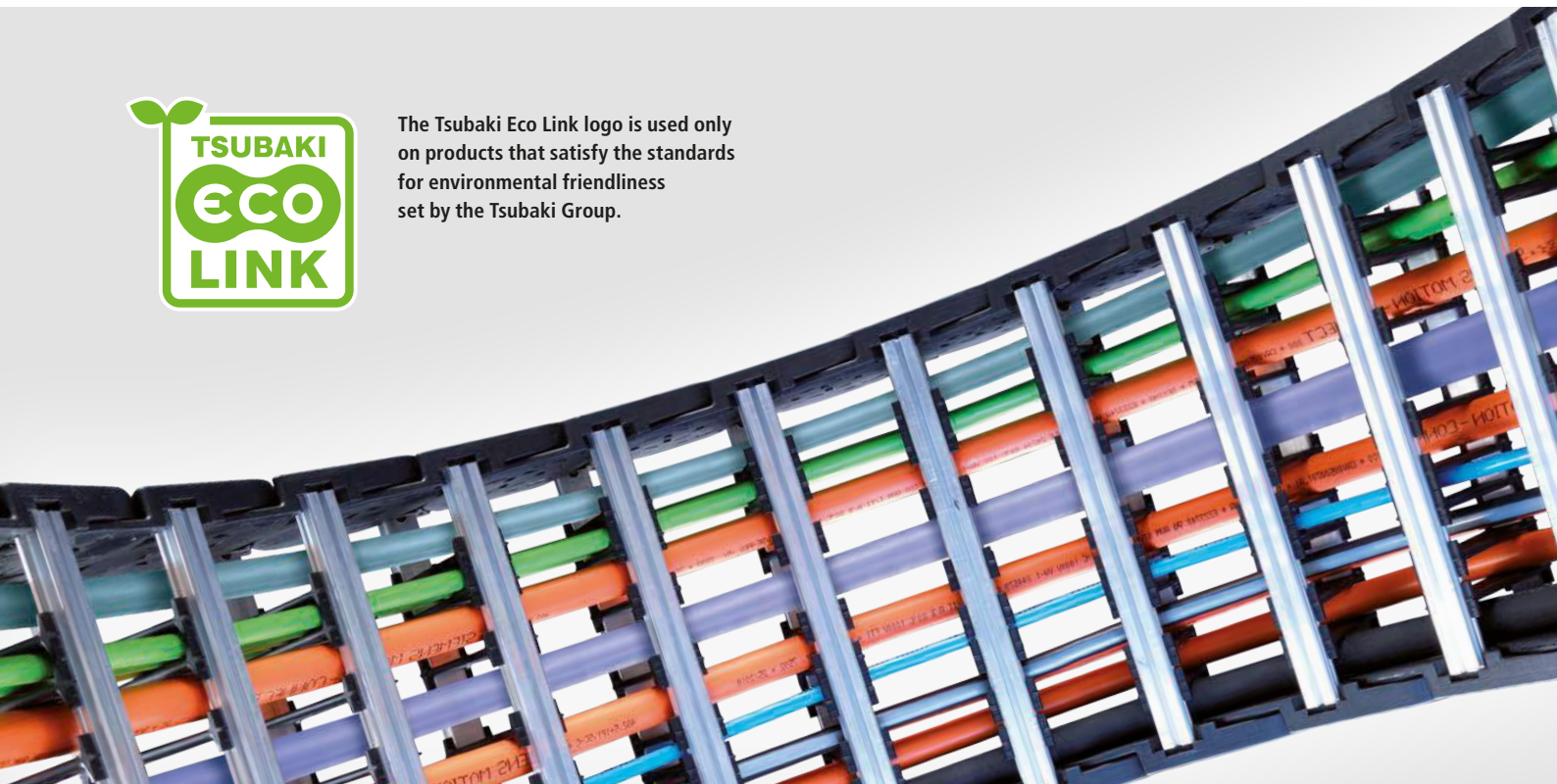

ECO & €CO – Ecology & Economy

We are advancing the development of environmentally friendly products to conserve the environment and reduce the environmental impact of our operations by improving the efficiency of production activities and developing products that effectively lower energy consumption.

These ECO & €CO products help customers reduce energy consumption and improve the economic aspects of their operations. Long-Term objective is to significantly reduce CO₂ emissions.

Detailed information on the ECO & €CO initiative can be found at kabelschlepp.de/ecolink





Innovative solutions

for the machine tool industry

ENERGY AND SIGNALS

- Cable Carrier Systems made of plastic
- Cable Carrier Systems made of steel
- Cable Carrier Systems for 3D movements
- TRAXLINE® Cables for Motion
- TOTALTRAX® Complete Systems – Ready-to-install

PROCESS MANAGEMENT

- Hinged belt conveyors
- Scraper conveyors
- Belt conveyors
- Part conveyors

MACHINE STRUCTURE

- Telescopic covers
- Way wipers
- Link apron covers
- Bellows
- Conical spring covers

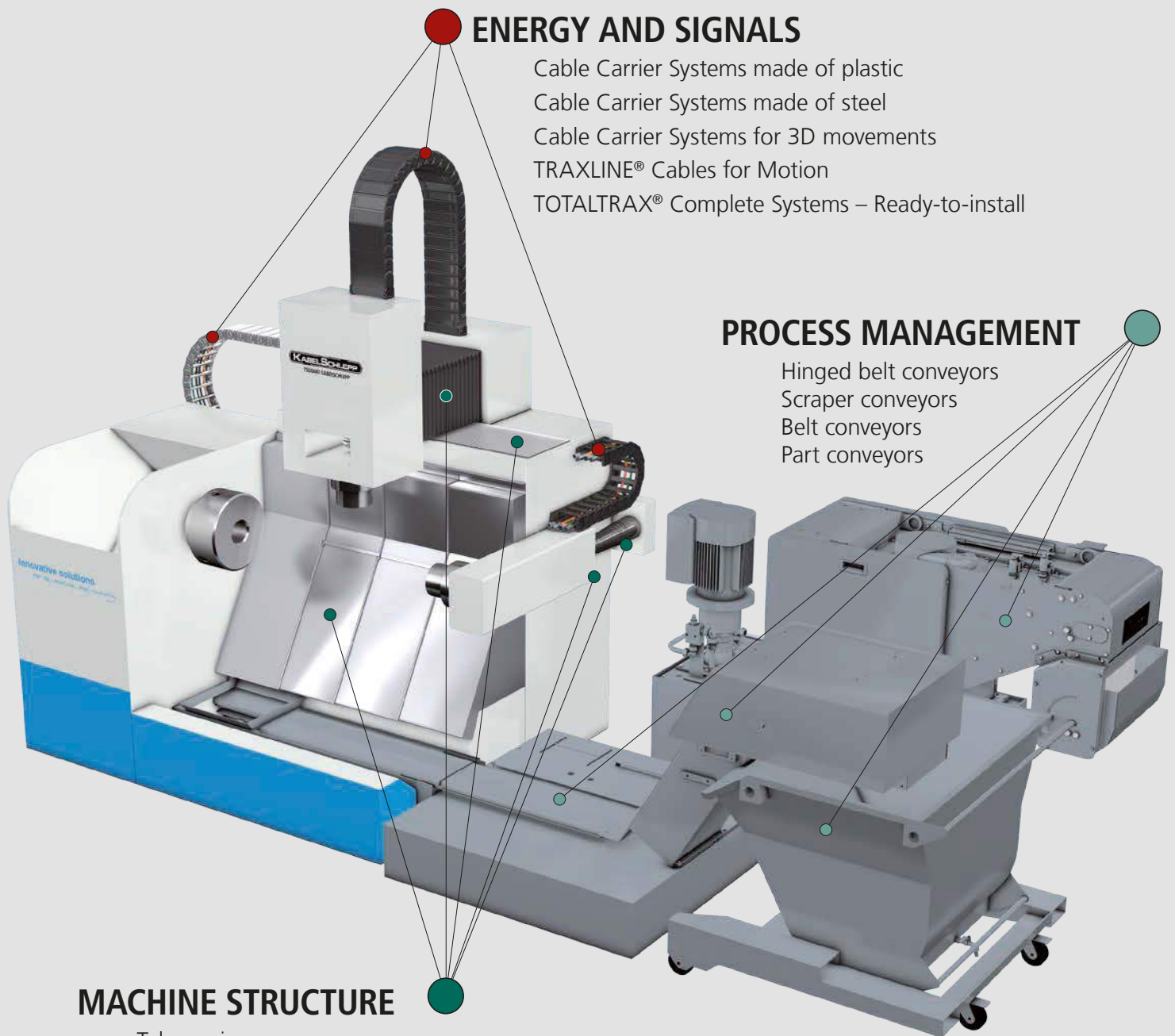

ENERGY AND SIGNALS see page 6



STANDARD
applications



ADVANCED
applications



EXTREME
applications



3D applications



TRAXLINE®
Cables for Motion

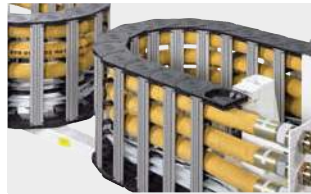

TOTALTRAX®
Ready-to-install



Application examples
see page 16

MACHINE STRUCTURE see page 18



Telescopic covers



Way wipers



Link apron covers



Bellows



Conical spring covers



Application examples
see page 24

PROCESS MANAGEMENT see page 20



Hinged belt conveyors

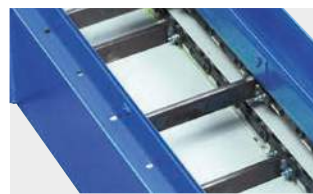

Scraper conveyors



Belt conveyors



Modular conveyors



Application examples
see page 24



ENERGY AND SIGNALS

STANDARD applications

Solid plastic cable and hose carrier systems with fixed chain widths

Reliable cable and hose carrier systems with simple designs for standard applications. Due to its vast range of various carrier types and designs, TSUBAKI KABELSCHLEPP can offer reliable and cost-efficient solutions such as extremely compact designs, types with non-opening or opening crossbars for fast and easy cable installation, as well as tube style options for superior protection from chips and other debris.

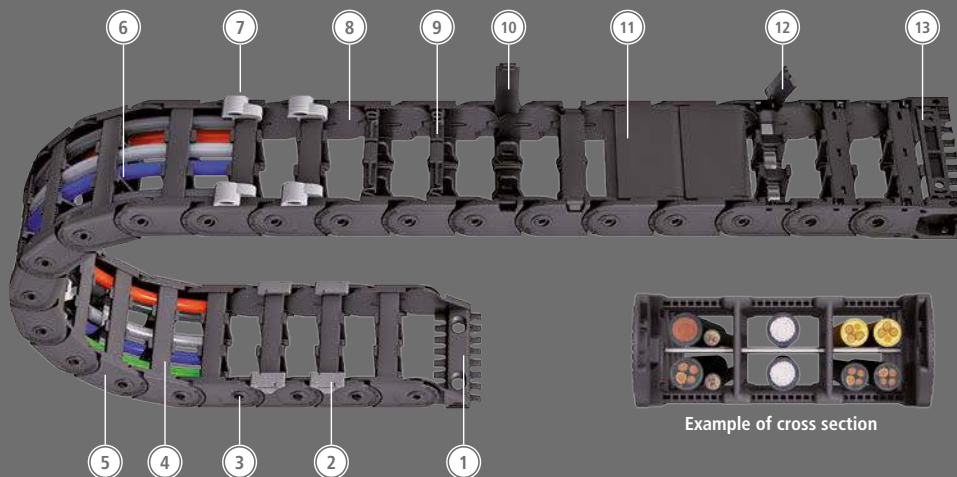

- 1 Mounting brackets with integrated strain relief
- 2 Replaceable glide shoes for extending system life
- 3 Robust, double stroke system for long unsupported lengths
- 4 Types with non-opening, single-part chain link design
- 5 Chain links made of plastic
- 6 Vertical and horizontal partitioning options separate and organize cables
- 7 Outer noise dampening elements
- 8 Inside space is gentle on the cables – no interfering edges
- 9 Very fast and easy cable installation by simply pressing in of the cables
- 10 Types with openable stays – for easy cable installation
- 11 Optional designs covered on one side or on both sides with plastic cover system
- 12 Types with detachable crossbars
- 13 Universal mounting brackets (UMB) with integrated strain relief comb

The assigned values are average values. Depending on the specific application, the maximum values may differ significantly. For detailed information please contact us.

MONO

Cable carriers with simple design for standard applications



- Simple single piece chain links design with either non-opening or hinged opening crossbars
- Simple and quick assembly
- Compact design for operation in tight spaces
- Mounting brackets with integrated strain relief

More Information:
kabelschlepp.de/mono

UNIFLEX Advanced

Light, quiet all-rounder for a wide range of applications

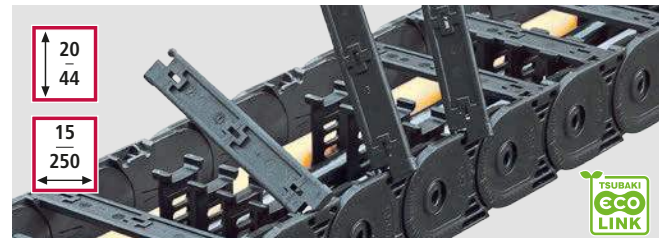

- Noise-optimized for quiet operation
- Designs with inward or outward opening or non-opening crossbars available
- Crossbars fast and easy to open due to ball joint hinge mechanism
- Dividers movable or fixed in place
- Long unsupported lengths
- Various cavity partitioning options for the cables

More Information:
kabelschlepp.de/uniflex-advanced

ENERGY AND SIGNALS

STANDARD applications

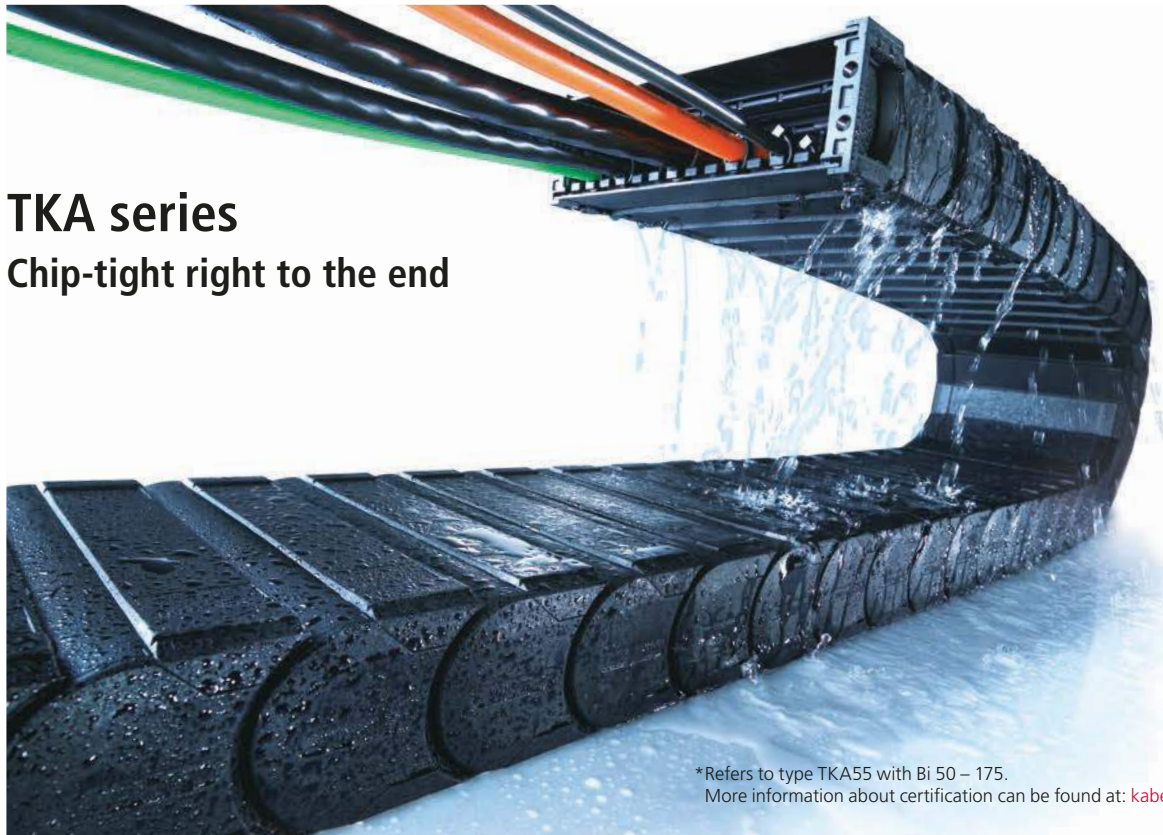

TKA series Chip-tight right to the end



*Refers to type TKA55 with Bi 50 – 175.
More information about certification can be found at: kabelschlepp.de/tka-ip54

Splash- and dustproof – in more than 300 variants

The enclosed cable and hose carrier TKA55 was specifically developed for use in environments with contamination from chips and dirt. The design effectively prevents the ingress of foreign bodies into the cable space and provides reliable protection of the cables, up to the protection class IP54 – tested and attested by the TÜV Nord (German Technical Inspection Authority, North).*

The optimized geometry of the chain links of the TKA series and the 3-fold, encapsulated stroke system enables exten-

sive unsupported length and high torsional rigidity. Integrated gliding surfaces also predestine them for long travel lengths. Easy to open cover provide secure hold, even under severe mechanical stresses, e.g. when used with hydraulic cables.

The TKA45, TKA38 and TKA30 types were developed modelled on the TKA55. There is a total of more than 300 versions available with inner widths of 15 to 250 mm and inner heights of 20.5 to 45 mm.



Versions available opening inwards or outwards



Cover system also in the connection area



Fixable dividers with arresting cams

More Information:
kabelschlepp.de/tka



ENERGY AND SIGNALS

STANDARD applications









TKA series

Chip-tight right to the end



- 1 Secure cover attachment even under severe stresses (e.g. due to hydraulic cables)
- 2 Designs with inward or outward opening covers
- 3 Cable-friendly interior space without sharp edges
- 4 Cover completely detachable on one side
- 5 Quick and easy opening from any vantage point
- 6 Connecting pieces with optional strain relief
- 7 Dividers and height separation for cables
- 8 Chain links made of glass fibre-reinforced plastic
- 9 Cover sheet for universal mounting bracket
- 10 Integrated noise damping system
- 11 Pin and bore connection and stroke system covered completely

Example of cross section

Pitch	Height	Width	Load	Travel path unsupported	Travel path gliding	Travel speed	Acceleration
							
30.5 – 55.5 mm	20.5 – 45 mm	15 – 250 mm	up to 10 kg/m	up to 6.5 m	up to 150 m	up to 9 m/s	up to 45 m/s ²

The assigned values are average values. Depending on the specific application, the maximum values may differ significantly. For detailed information please contact us.

Splash- and dustproof – in more than 300 variants

- Impermeability against chips, excellent cable protection also in the connection area
- TKA55: IP54 tested and attested (TÜV NORD)*
- On request, also in special material with protection against hot chips up to 850 °C
- Quick routing of the cables, easy to open
- Inner or outer opening variants available
- Extensive unsupported length due to 3-fold stroke system
- Integrated gliding surfaces for gliding arrangements
- Suppressed against vibration and noise using an internal damping system
- High torsional rigidity

			
TKA30	TKA38	TKA45	TKA55
			
6 inside widths 15 – 65 mm	6 inside widths 25 – 130 mm	5 inside widths 50 – 150 mm	9 inside widths 50 – 250 mm

More Information:
kabelschlepp.de/tka

*Refers to type TKA55 with Bi 50 – 175. More information about certification can be found at: kabelschlepp.de/tka-ip54

ENERGY AND SIGNALS

ADVANCED applications

Cable and hose carrier systems with variable chain widths

With more than 50.000 design options, ranging from easy-to-open/snap-open or bolted-on frame stay systems to cavity extender systems guiding large vacuum hoses to enclosed tube frame stay systems that provide superior protection from dirt and debris, We offer the ideal solution to fit any application. As an example, cable carriers with linkless design can operate at extreme speeds. Numerous frame stay options allow even the most complex cable configurations to be safely and efficiently partitioned within the carrier cavity.

- ① C-Profile strain relief elements
- ② Minimized hinge wear due to the "life extending 2 disc principle"
- ③ Replaceable glide shoes
- ④ Extremely robust due to heavy-duty link plate/sideband design
- ⑤ Vast selection of cavity partitioning options
- ⑥ Aluminum frame stays available in 1 mm width increments
- ⑦ Plastic covers available in 8 or 16 mm width increments
- ⑧ Crossbars can be quickly opened on the inside or outside radius for easy cable installation
- ⑨ Plastic crossbars available in 4, 8 or 16 mm width increments
- ⑩ Aluminum covers available in 1 mm width increments
- ⑪ Aluminum frame stays with ball joint hinge mechanism
- ⑫ Universal mounting brackets (UMB)

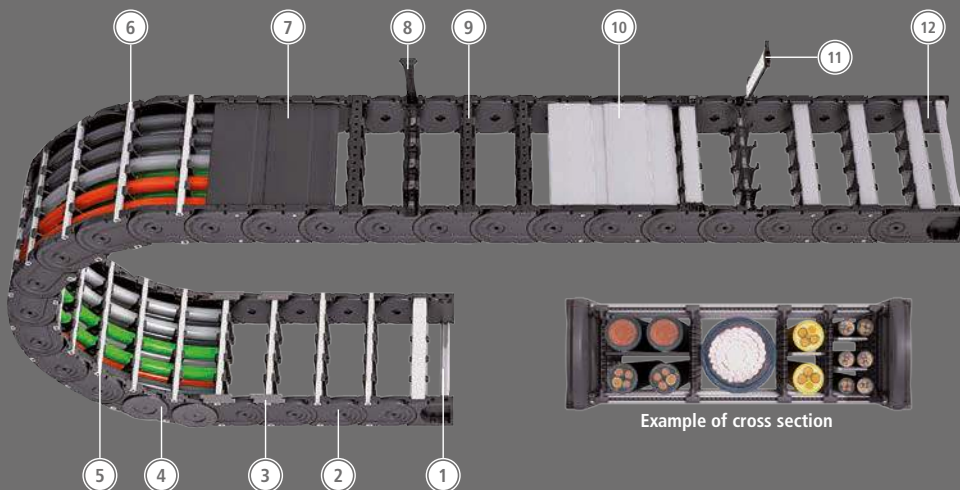

The assigned values are average values. Depending on the specific application, the maximum values may differ significantly. For detailed information please contact us.

MASTER Series

Quiet and weight-optimized carriers



- Light design with weight-optimized sideband construction
- Excellent ratio of inside to outside height
- Customized bend radii are available
- Plastic covers available

More Information:
kabelschlepp.de/master

M Series / MT Series

Robust and versatile all-rounder



- Various separation options
- Large selection of frame stay systems
- Ideal for fast, gliding applications: Replaceable glide shoes made of highly wear-resistant special plastic material
- Plastic or aluminum covers available

More Information:
kabelschlepp.de/m-series

QUANTUM®

Light, quiet, low-vibration



- Suitable for clean room environments
- Allows for high acceleration and high travel speeds
- Long service life – no link pins to wear out
- Linkless design: sidebands made of extruded material

More Information:
kabelschlepp.de/quantum



ENERGY AND SIGNALS

EXTREME applications

Steel/stainless steel cable carrier systems – solutions for extreme applications

Lubricant-free cable and hose carrier systems made of steel or stainless steel for applications in extreme environments. Steel and stainless steel carrier systems are the carrier of choice for operation in extreme heat or the harshest environments. We offer various carrier types and designs ranging from compact style to super-sized carriers. Customized cavity partitioning as well as aluminum cover systems provide optimum cable protection even under heavy mechanical loads/stress.

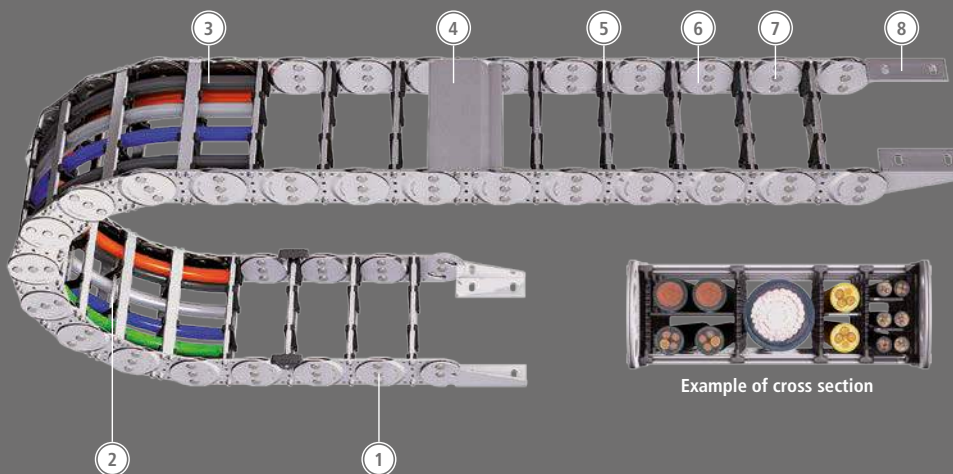

- 1 Link design with special bolts for a long service life
- 2 Various cable separation options
- 3 Dividers made of plastic or steel
- 4 Aluminum cover available in custom 1 mm width increments
- 5 Various frame stay options available customizable in 1 mm width increments
- 6 Extremely robust sidebands zinc plated or made of stainless steel
- 7 All steel cable carriers are lubricant-free
- 8 Variety of mounting bracket options available

STAINLESS STEEL
RUST-FREE

STEEL
ZINC PLATED

The assigned values are average values. Depending on the specific application, the maximum values may differ significantly. For detailed information please contact us.

LS/LSX Series

Cost-effective, light-weight steel chains



- Improved dynamic characteristics due to weight-optimized design
- Long unsupported lengths for small to medium additional loads
- Cover with steel band for optimum cable protection available on request

More Information:
kabelschlepp.de/ls-lsx

S/SX Series

Extremely robust and heavy-duty steel chains



- Extremely robust and heavy-duty steel chains for large mechanical loads and harsh environmental conditions
- Very long unsupported lengths even for heavy additional loads
- Various types in different dimensions available
- Aluminum cover available for maximum protection of the cables

More Information:
kabelschlepp.de/s-sx

ENERGY AND SIGNALS

3D applications

ROBOTRAX® System – Cable and hose carrier systems for 3D movements

ROBOTRAX® – cable and hose carrier system for robotic applications – is safe and gentle on the cables. Downtimes are reduced to a minimum. The open-style design allows for fast and easy installation and inspection of cables and hoses once installed. The ROBOTRAX® series offers a vast assortment of accessories to perfectly fit the carrier system to the individual application. Solutions include accessories for impact protection, shock and vibration dampening, and heat sleeves for optimum cable protection.

- ① Steel wire for transmission of extremely large tensile forces
- ② Protective covers or heat shields made of various materials are available for a diverse range of environmental conditions
- ③ Quick-opening mounting brackets easily attach any link of the ROBOTRAX® system to any mounting point on the robot
- ④ Fast cable installation by simply pressing the cables into the carrier system's cavity partitions: no threading through is required
- ⑤ Special plastic material for long service life

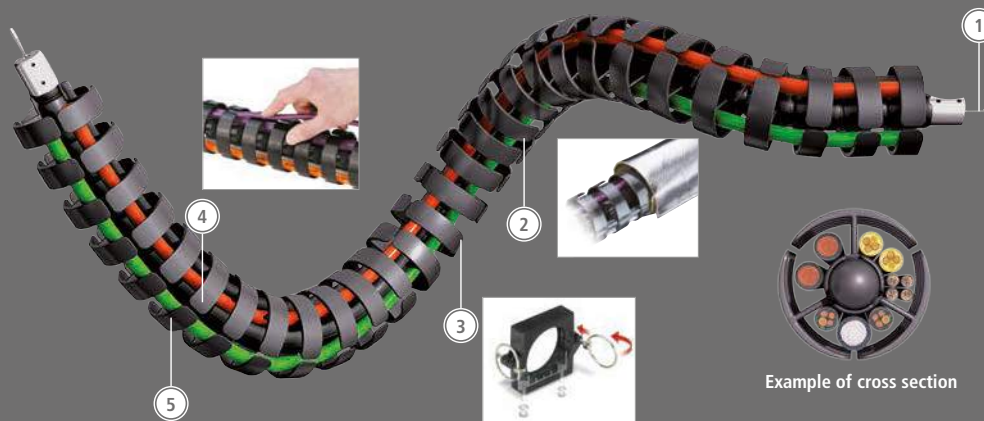

Width	Sub-division
	
27 – 64 mm	several
Height	
	
10 – 31 mm	

The assigned values are average values. Depending on the specific application, the maximum values may differ significantly. For detailed information please contact us.

ROBOTRAX® System

LineFix saddly-type clamps for strain relief



For secure and gentle cable installation. Multilayer strain relief with double and triple clamps available. Multiple systems can also be mounted one behind the other.

More Information:
kabelschlepp.de/robotrax

PULL-BACK-UNIT – PBU

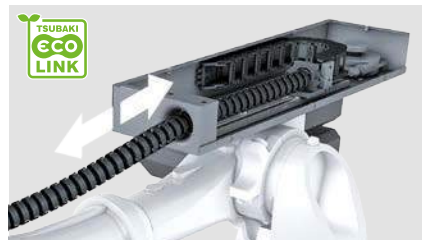

Rapid, repetitive movements of relatively long cable carrier systems in large operating envelopes, constantly hitting the robot arm, are to blame for reducing the service life of the carrier and installed cables. This can lead to a failure of the overall robotic system with expensive downtime and production outages. By using the PULL-BACK UNIT, the service life of the cable carrier and cables is significantly extended, downtimes are kept to a minimum.

PROTECTOR



The service life of the cable carriers and cables is significantly reduced through impacts when moving quickly and large operating areas. The PROTECTOR protects the cable carrier from hard impacts, excessive abrasion and premature wear and, simultaneously, provides limiting of the smallest bend radius. Downtimes are minimized. The complete cable carrier must not be replaced, but only the PROTECTOR.

Innovative solutions

for the machine tool industry



kabelschlepp.de/machinetools/gb

ENERGY AND SIGNALS

TRAXLINE®

Our Series 700 meets the highest quality standards to ensure the continuous availability of your application. The TRAXLINE® product range offers high-flex cables that are extremely durable and especially designed for being used in cable carriers. A main feature is their tested and proven operational reliability, which meets the applicable standards and directives. Competent, objective-driven system consultation and a global onsite service are part of our ongoing commitment to technical and commercial optimization.

Properties:*

- oil-resistant
- hi-flex design
- UV-resistant/UV-stable
- RoHS-conform
- metermarked
- halogen-free
- CFC-free
- silicone-free
- flame-retardant
- ozone-resistant

* some properties are type-dependent; please contact us.

TRAXLINE® CAT.5E / CAT.6 700 CD

Double-shielded continuous bending hi-flex CAT.5E / CAT.6 PUR cable



Conductor:
extremely fine stranded conductors of bare copper wires in an optimized hi-flex design

Shielding:
coverage 85 %
Outer jacket:
PUR

Temperature range moved:
- 20 up to + 60 °C
Minimum bend radius moved:
 $KR_{min} \geq 10 \times \varnothing$

V_{max} un_supp.:
3 m/s
V_{max} gliding:
3 m/s
a_{max}: 3 m/s²
Insulation resistance:
 $\geq 150 \text{ M}\Omega \times \text{km}$

Approvals:
cURus, based on VDE
Varying parameters possible – please contact us



Core insulation PP
stranded in pairs



Outer jacket PUR
pressure extruded hi-flex design, UV-resistant extremely abrasion-resistant



Overall double-shielding
continuous bending hi-flex, tin-plated copper braiding Coverage: approx. 85 % and foil shield

TRAXLINE® System S 700 C

Shielded continuous bending hi-flex PUR signal cables



Conductor:
extra-fine wire conductor made from bare or tin-plated copper wires, design-optimized for maximum flexural strength

Shielding:
coverage min. 83 % (type-dependent)
Outer jacket:
PUR

Temperature range moved:
- 30 up to + 80 °C
Minimum bend radius moved:
 $KR_{min} \geq 7.5 \times \varnothing$

V_{max} un_supp.:
5 m/s
V_{max} gliding:
5 m/s
a_{max}: 50 m/s²
Insulation resistance:
 $\geq 20 \text{ M}\Omega \times \text{km}$

Approvals:
cURus, based on VDE
Varying parameters possible – please contact us



Core insulation PP
hybrid stranded



Element shield
continuous bending hi-flex, in-plated braided copper shield with the option of foil shield



Overall shield
continuous bending hi-flex, tin-plated copper braiding for smallest bend radii Coverage: min. 83 %



Outer jacket PUR
pressure extruded hi-flex design, UV-resistant extremely abrasion-resistant

TRAXLINE® Profibus 700 C

Shielded continuous bending hi-flex Profibus PUR cables



Conductor:
extremely fine stranded conductors of bare copper wires in an optimized hi-flex design

Shielding:
coverage 70 %
Outer jacket:
PUR

Temperature range moved:
- 30 up to + 70 °C
Minimum bend radius moved:
 $KR_{min} \geq 12 \times \varnothing$

V_{max} un_supp.:
3 m/s
V_{max} gliding:
2 m/s
a_{max}: 3 m/s²
Insulation resistance:
 $\geq 10 \text{ M}\Omega \times \text{km}$

Approvals:
cURus, based on VDE
Varying parameters possible – please contact us



Core insulation PE-Foam
stranded in pairs



Inner jacket PP/TPE
valley-sealed, pressure extruded, hi-flex design



Overall shield
continuous bending hi-flex, tin-plated copper braiding Coverage: approx. 70 % and foil shield



Outer jacket PUR
pressure extruded hi-flex design extremely abrasion-resistant

TRAXLINE® System M 700 C

Shielded continuous bending hi-flex PUR motor/servo drive cables



Conductor:
finely stranded conductors of bare copper wires in an optimized hi-flex design

Shielding:
coverage min. 83 % (type-dependent)
Outer jacket:
PUR

Temperature range moved:
- 30 up to + 80 °C
Minimum bend radius moved:
 $KR_{min} \geq 7.5 \times \varnothing$

V_{max} un_supp.:
5 m/s
V_{max} gliding:
5 m/s
a_{max}: 50 m/s²
Insulation resistance:
 $\geq 30 \text{ M}\Omega \times \text{km}$

Approvals:
cURus, based on VDE
Varying parameters possible – please contact us



Core insulation PP
hybrid stranded



Element shield
continuous bending hi-flex, in-plated braided copper shield with the option of foil shield



Overall shield
continuous bending hi-flex, tin-plated copper braiding for smallest bend radii Coverage: min. 83 %



Outer jacket PUR
pressure extruded hi-flex design, UV-resistant extremely abrasion-resistant

ENERGY AND SIGNALS

TRAXLINE® Power ONE 700 PE

Unshielded, continuous bending highly-flexible PUR single-core cables with PE core identification



Conductor:
conductors
class 6 of bare
copper wires
in an optimized
hi-flex design

Outer jacket:
PUR

**Temperature
range moved:**
– 35 up to
+ 90 °C
**Minimum bend
radius moved:**
 $KR_{min} \geq 7.5 \times \varnothing$

**V_{max} unsp.:
20 m/s**
**V_{max} gliding:
5 m/s**
a_{max}: 50 m/s²
**Insulation
resistance:
≥ 100 kΩ x km**

Approvals:
cURus,
based on VDE
Varying
parameters
possible –
please
contact us



Core insulation PP
wire bundles
in short pitches



Outer jacket PUR
pressure extruded
hi-flex design
extremely abrasion-resistant



Jacket colour black
ozone-resistant
UV-resistant

TRAXLINE® Data 700 TPi C

Shielded continuous bending hi-flex PUR data cables



Conductor:
conductors
class 6 of bare
copper wires
in an optimized
hi-flex design

Shielding:
coverage
nom. min. 83 %
Outer jacket:
PUR

**Temperature
range moved:**
– 35 up to
+ 90 °C
**Minimum bend
radius moved:**
 $KR_{min} \geq 7.5 \times \varnothing$

**V_{max} unsp.:
20 m/s**
**V_{max} gliding:
5 m/s**
a_{max}: 50 m/s²
**Insulation
resistance:
≥ 30 MΩ x km**

Approvals:
cURus,
based on VDE
Varying
parameters
possible –
please
contact us



Core insulation PP
stranded in pairs



Overall shield
continuous bending hi-flex,
tin-plated copper braiding
for smallest bend radii



Jacket colour black
ozone-resistant
UV-resistant



Inner jacket TPE
valley-sealed,
pressure extruded,
hi-flex design



Outer jacket PUR
pressure extruded
hi-flex design
extremely abrasion-resistant

TRAXLINE® Control 700 600 V

Unshielded continuous bending hi-flex PUR control cables



Conductor:
conductors
class 6 of bare
copper wires
in an optimized
hi-flex design

Outer jacket:
PUR

**Temperature
range moved:**
– 35 up to
+ 90 °C
**Minimum bend
radius moved:**
 $KR_{min} \geq 7.5 \times \varnothing$

**V_{max} unsp.:
20 m/s**
**V_{max} gliding:
5 m/s**
a_{max}: 50 m/s²
**Insulation
resistance:
≥ 30 MΩ x km**

Approvals:
cURus,
based on VDE
Varying
parameters
possible –
please
contact us



Core insulation PP
bundled stranding
(> 8 cores)



Jacket colour black
ozone-resistant
UV-resistant



Outer jacket PUR
valley-sealed extruded
hi-flex design
extremely abrasion-
resistant

TRAXLINE® Power 700 C 1 kV

Shielded continuous bending hi-flex PUR power cables



Conductor:
conductors
class 6 of bare
copper wires
in an optimized
hi-flex design

Shielding:
coverage
nom. min. 83 %
Outer jacket:
PUR

**Temperature
range moved:**
– 35 up to
+ 90 °C
**Minimum bend
radius moved:**
 $KR_{min} \geq 7.5 \times \varnothing$

**V_{max} unsp.:
20 m/s**
**V_{max} gliding:
5 m/s**
a_{max}: 50 m/s²
**Insulation
resistance:
≥ 30 MΩ x km**

Approvals:
cURus,
based on VDE
Varying
parameters
possible –
please
contact us



Core insulation PP
bundled stranding
(> 8 cores)



Overall shield
continuous bending, hi-flex,
tin-plated, copper braiding for
smallest bend radii



Inner jacket TPE
valley-sealed,
pressure extruded,
hi-flex design



Outer jacket PUR
pressure extruded,
hi-flex design, extremely
abrasion-resistant



Jacket colour black
ozone-resistant
UV-resistant

Find the complete TRAXLINE® cable programme on our website: kabelschlepp.de
Or please contact us – our experts will be glad to advise you.



ENERGY AND SIGNALS

Cut costs with TOTALTRAX® complete cable carrier systems

Use our know-how. Working closely with you, our experienced system specialists can provide pre-sale support, including planning and design services through post sales service and support. Only one contact person for the complete system.

All components match each other perfectly, including your cable carriers, electrical cables, hydraulic and pneumatic hoses as well as connectors. You'll receive the complete system in one delivery, with guarantee certificate if desired – in short: TOTALTRAX®.

Reduce your storage costs for cable and hose carriers, cables and connectors with TOTALTRAX®. We supply all components Just-In-Time to your production facility or directly to the installation site.

Everything from a single source:

- Consulting
- Planning
- Design
- Cable carriers
- Power & control cables
- Complete guarantee
- Hydraulic hoses
- Pneumatic hoses
- Plug-and-socket connectors
- Assembly plates
- Complete assembly of all components

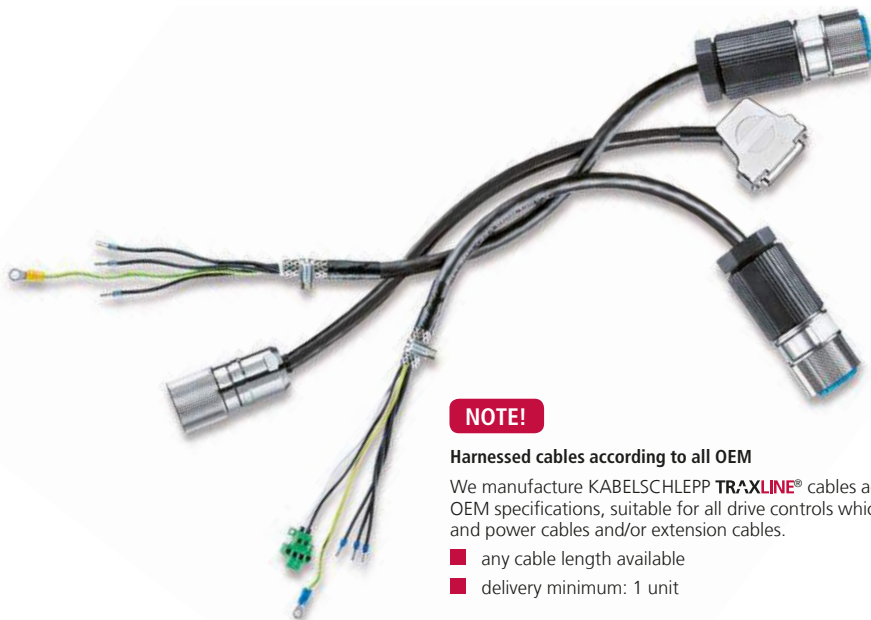
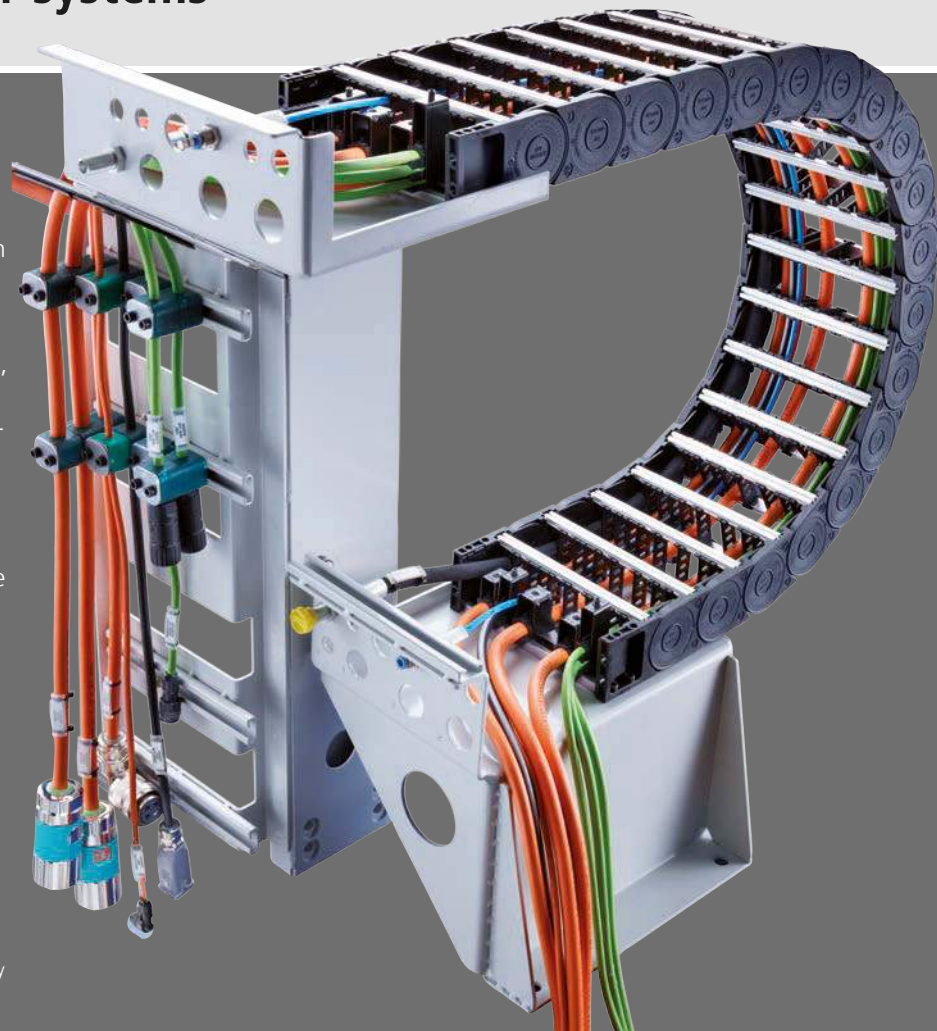

NOTE!

Harnessed cables according to all OEM

We manufacture KABELSCHLEPP TRAXLINE® cables according to OEM specifications, suitable for all drive controls which consist of signal and power cables and/or extension cables.

- any cable length available
- delivery minimum: 1 unit



ENERGY AND SIGNALS

Cut costs with TOTALTRAX® complete cable carrier systems

We help you ...

- Advice on planning
- Support in the design phase
- Only one contact person for the complete system including all the individual components
- Complete delivery from a single source
- Only one supplier – one purchase order and one item number
- All components match each other perfectly
- Guarantee certificate upon requests



... to cut your costs!

- Goods receiving inspections for all individual components are no longer required
- Expensive technical personnel and special tools are no longer required
- Shorter assembly times
- No hidden costs, e.g. cables being cut to excessive lengths etc.
- Less captive capital with almost no inventory
- On-time delivery directly to your production site

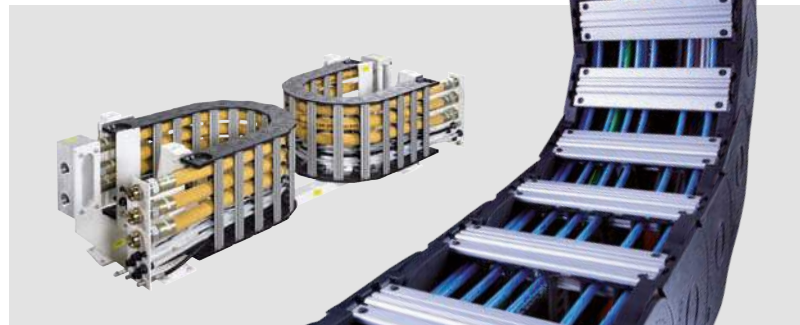
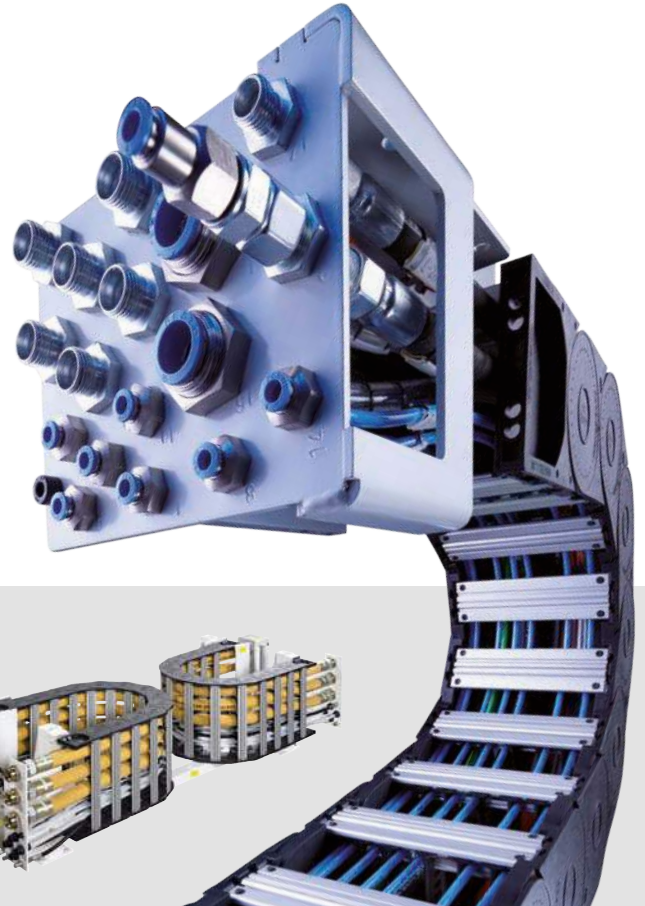

OnlineEngineer.de
TSUBAKI KABELSCHLEPP
Cable Carrier Configurator



Online configuration tool for cable carrier systems

Using TSUBAKI KABELSCHLEPP **OnlineEngineer**, in just a few clicks of the mouse you can **quickly select and configure** the optimal TSUBAKI KABELSCHLEPP cable carrier system for your application. Just input the parameters of your application and the OnlineEngineer will **automatically calculate** the TSUBAKI KABELSCHLEPP cable carrier system with the **optimal price/performance ratio!** Alternatively, you can follow easy step-by-step menus and individually design your desired cable carrier system.

Finally, if you already know which TSUBAKI KABELSCHLEPP cable carrier systems you would like to use, just enter the order specifications and you will receive all applicable information by mouse click. Since any and all functions can be combined, the specification data needs to be entered only once. A corresponding **2D drawing or 3D model** of your carrier can be immediately downloaded.



Save time with our 2D & 3D drawing library available online

Our 2D and 3D CAD drawings simplify the job for your design engineers. You can find the data for our cable carriers in the **CADENAS** component libraries. TSUBAKI KABELSCHLEPP provides free drawing libraries. Once selected CAD data can be saved or exported in a wide range of formats for import into your CAD system. Can't find what you are looking for, please contact us.

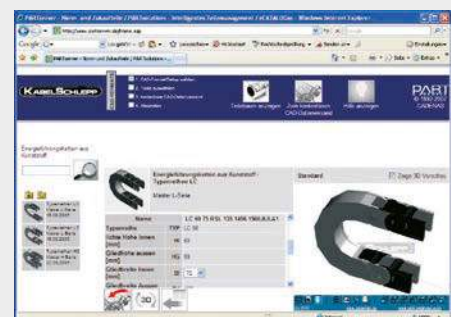



ENERGY AND SIGNALS

Application examples

Decades of application experience in hundreds of market segments and with thousands of product combinations result again and again in new tailor-made and user oriented solutions for our customers.

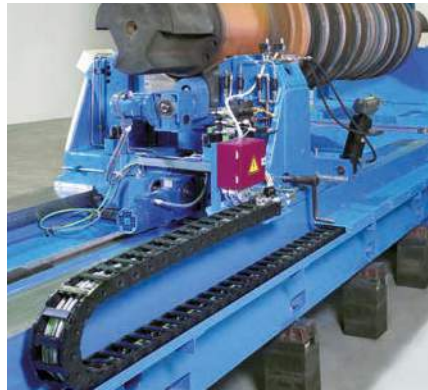

Plastic cable carriers on a roll neck milling machine.
Photographs: Rottler Werkzeugmaschinen GmbH

Cable carrier system TKA Series on a machining center

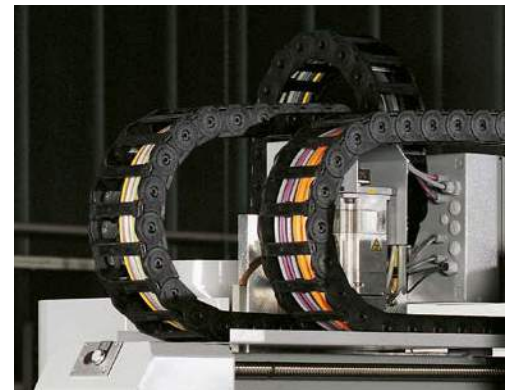

Plastic cable carrier on a CNC-machining center. Photographs: Reichenbacher GmbH



Cable carriers of the MASTER LT series on a tube end processing machine. Photographs: Rottler Werkzeugmaschinen GmbH

ENERGY AND SIGNALS



ROBOTRAX®, K Series and M Series cable carriers on a laser cutting machine. Photograph: Soudronic AG Automotive

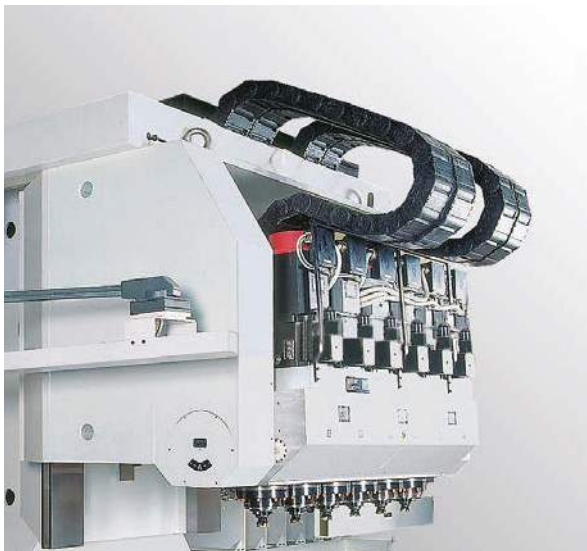

M Series cable carrier on a high-performance machining center. Photograph: Liechti Engineering AG

QUANTUM® cable carrier system on a handling system

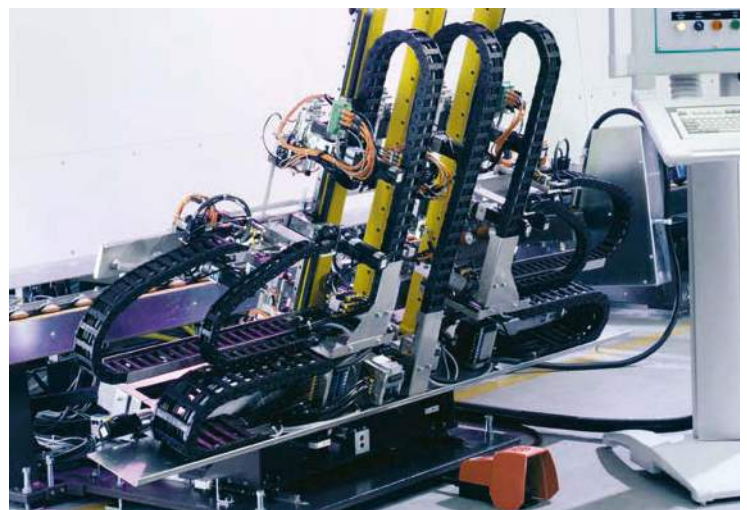
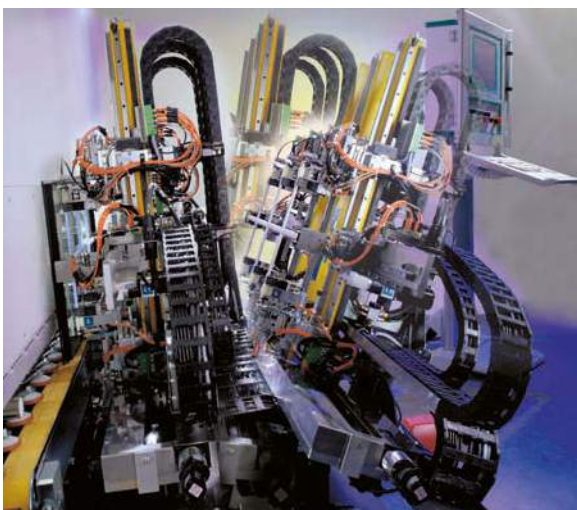

Plastic cable carriers on an automatic window frame setting station. Photographs: Lenhard Maschinenbau GmbH



MACHINE STRUCTURE

Telescopic covers

Perfect protection for guideways on machine tools

Today, modern machine tools process workpieces at ever-greater cutting and travel speeds. The protection of guideways, measuring systems, drive elements and other vulnerable parts is absolutely essential. Accelerations and speeds of machines are constantly increasing. Telescopic covers must also be able to cope with these challenges. This is where telescopic covers with harness mechanisms are used. So-called differential drives serve to synchronize the boxes and eliminate impact pulses.



Proven Waterjet Protection:
DIN EN 60529 – IPX6

Reliable and Impact Resistant: DIN EN
50102 – IK08 (10)

TA	TA
IPX6	IK08
getestet & bescheinigt tested & attested	getestet & bescheinigt tested & attested

Please contact us for more information – we will be glad to advise you.

SXM
KABELSCHLEPP
Synchronized Expansion Mechanism

The KABELSCHLEPP harness technology is used wherever you find this symbol.



Designs

Machine tools come in a wide variety of designs. That is why a modern lathe needs another type of telescopic cover than, for example, a large bed-type milling machine. The following designs provide an overview of typical designs.

Way wipers

The cleanup crew

Way wipers are essential to keep the guideways in a proper functional state, and thus to keep the machine tool permanently in operation. Even if the guideways are already protected by a telescopic cover, it is necessary to wipe fine, penetrating particles off of the vulnerable ways.

Designs

Available in a wide variety of shapes, harnessed according to your specifications, in bar form or available ex-stock.



More Information:

Fon +49 (0)2762 4003-0 or Online: kabelschlepp.de/machinetools/gb

Subject to change.

MACHINE STRUCTURE

Link apron covers

Solutions for limited spaces

Link apron covers can be used anywhere where, for reasons of space, it is not possible to use telescopic covers. They lie directly on the guideways and can hang down freely at the end of the path, or be screwed on or wound around without any special guides.

Properties

- Small space requirement
- Protection against chips and lubricant
- Protection against most cooling lubricants, oil, grease, dirt and dust
- Splash- and hose-proof
- Low weight
- Long service life
- Heat-resistant to 100 °C over extended periods
- Customized end attachment
- Can be supplied with a roller device (type-dependent)
- Liquid-tight or self-extinguishing versions possible
- Short delivery time
- Attractive price/performance ratio



Bellows

Guideway protection solutions with very little compression

Bellows are used on all kinds of machine to provide protection for guideways and spindles

Properties

- Simple installation
- High travel speed
- Minimal compression
- High quality
- Protection against most cooling lubricants, oil, grease, dirt and dust
- Liquid-tight or self-extinguishing versions possible



Conical spring covers

Protection under extreme conditions

Our conical spring covers are energy efficient. They follow the machine movements automatically. Conical spring covers protect spindles, columns, shafts, threads and rod guides reliably against contamination, chips and mechanical damage. They provide a good sealing function, and are self-cleaning if installed in a suitable position. High temperature resistance and resistance to chemicals guarantee reliable protection even under extreme operating conditions.

Properties

- Accident prevention for operating personnel from revolving spindles and shafts
- Reduction in downtimes resulting from contamination
- Increased machine service life
- Some conical spring covers are also available for retrofitting





PROCESS MANAGEMENT

Hinged belt conveyors

Proven for a wide range of disposal tasks

Transportation of the material takes place on the upper trough of a revolving hinged belt. Drivers ensure transport of the material up the inclined section. For wet machining the cooling lubrications are collected in the conveyor housing and can be fed back into the machine circuit via an optionally available coolant container or a pump station. Our hinged belt conveyors can be used either as stand-alone conveyors at machine tools, or as linked conveyor systems. Depending on the design, the material to be conveyed is brought to the required height at a defined incline and then discharged.

Structure

- Stable metal plate construction
- Standardized housing cross-section with variable width
- Robust worm gear motor
- Customized discharge height
- Customized incline standards = 30°, 45° and 60°
- Floor mounting or as a push-in version into the machine base

Accessory examples

- Motor monitoring systems with current-monitoring relay
- Other overload safety devices (on request)
- Coolant container with pump station
- Direct electrical connection to your machine controller
- Other special solutions are available.
- Please do get in touch with us, we will be happy to advise you.



This way we can solve your disposal tasks in over 80 % of all cases:

- Wet or dry chips
- Workpieces and waste
- Hot forgings
- Stampings and punching scrap
- And much more

Types and main areas of application

SRF 040.00 – the elegant “small one”, and particularly compact

Pitch of the hinged belt
t = 40 mm

With its small pitch (40 mm) and extremely compact design, this conveyor is suitable for even the smallest machine tools.



SRF 063.00 – the “classic”, and our best seller

Pitch of the hinged belt
t = 63 mm

The conveyor type for most mechanical engineering applications.



SRF 100.00 – the “big one” and especially robust

Pitch of the hinged belt
t = 100 mm

With a pitch of 100 mm, this conveyor is particularly useful when large quantities of chips are present.



SRF 150.00 – the “strongest” one we build

Pitch of the hinged belt
t = 150 mm

Special solutions with 150 mm pitch for transporting away of large outputs or large parts.



Standard dimensions

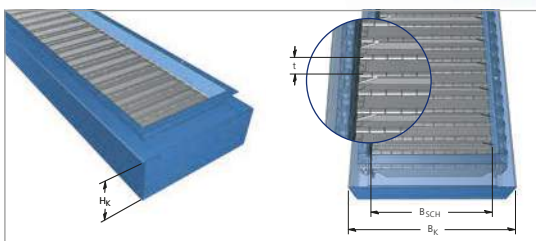

Type	Pitch t	Box height H _K	Hinged belt width B _{SCH}	Box width B _K
SRF 040.00	40	140	150, 200, 250, 300, 450, 600	B _{SCH} + 75 mm
SRF 063.00	63	216	150, 300, 450, 600, 750, 900	B _{SCH} + 120 mm
SRF 100.00	100	360	150, 300, 450, 600, 750, 900	B _{SCH} + 150 mm
SRF 150.00	150	540	300, 450, 600, 750, 900	B _{SCH} + 190 mm

Special widths on request.

PROCESS MANAGEMENT

Hinged belt designs



Hinged belt (standard)
for dry materials and chips with a low proportion of coolant



Hinged belt with perforations
for pre-separation of coolant for materials with a high proportion of coolant



Hinged belt conveyor with corrugations
for transporting adhering parts

Hinged belt conveyor with Wave-Belt System

No hinge – low wear

Chips and dirt can accumulate in the hinges with conventional hinge belt conveyors.

The WAVE-BELT System has no hinges on the top side of the belt and is smooth in this area. Chips and dirt cannot get trapped. Due to the "WAVE-FORM" of the belt plates, there is hardly any gap between the plates. **This makes the hinge belts tighter, have a longer service life and require less maintenance.**

The side rims have also been further developed so that almost no conveyed material can get trapped in this area. In this way, **wear and the risk of failure are reduced.**

Hinged belt conveyor with WAVE-BELT System

- Longer service life due to optimized belt design
- Tighter than conventional belts, as there are no hinges
- Extremely stable due to special shaping of the individual belt plates
- Easy to maintain due to bolted and thus very easily replaceable belt plates

Easy replacement of individual hinge belt plates

The belt plates are bolted and can be easily replaced if needed without having to dismantle the complete conveyor belt.



Replacement of individual hinge belt plates at the discharge

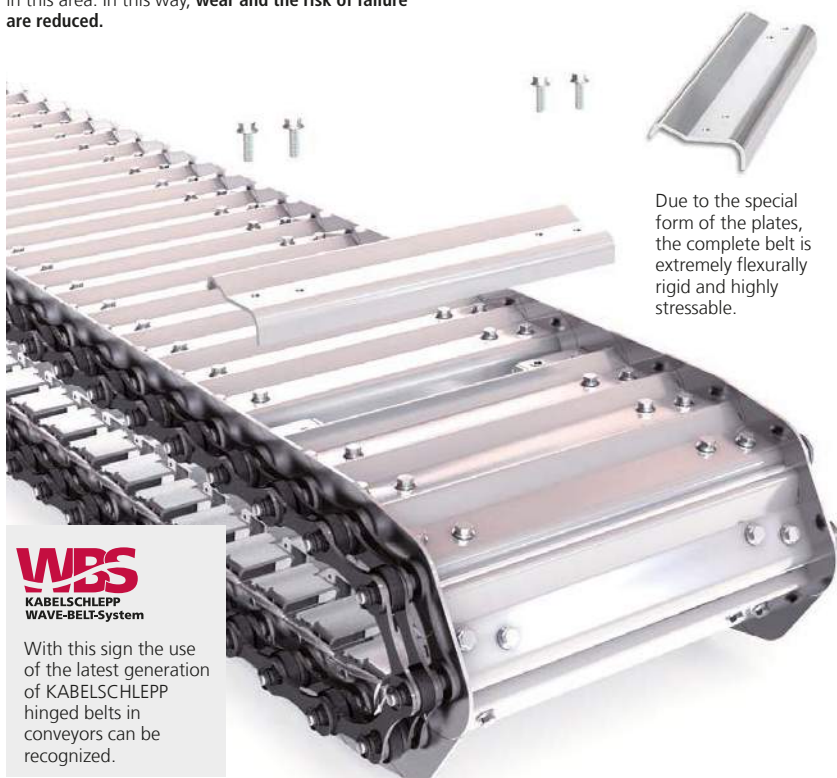

Due to the special form of the plates, the complete belt is extremely flexurally rigid and highly stressable.



With this sign the use of the latest generation of KABELSCHLEPP hinged belts in conveyors can be recognized.

More Information:

Fon +49 (0)2762 4003-0 or Online: kabelschlepp.de/machinetools/gb



PROCESS MANAGEMENT

Scraper conveyors

For disposal of small materials

Transport of the material takes place via drivers which push the material along the floor of the housing towards the discharge. Cooling lubricants are collected in the conveyor housing and can be fed back into the machine circuit via an added-on container or a pumping unit. Our scraper conveyors can be used as stand-alone conveyors at machine tools or as linked conveyor systems. Depending on the design, the material to be conveyed is brought to the required height at a defined incline and then discharged.

Structure

- Stable metal plate construction
- Standardized housing cross-section with variable width
- Robust worm gear motor
- Customized discharge height
- Customized incline standards = 30°, 45° and 60°
- Floor mounting or as a push-in version into the machine base

Accessory examples

- Motor monitoring systems with current monitoring relay
- Other overload safety devices (on request)
- Coolant container with pump station
- Direct electrical connection to your machine controller
- Other special solutions are available. Please do get in touch with us, we will be happy to advise you.



The solution for small and short chips:

- Frequently used for machining of non-ferrous metals
- Can also be used for very hard, short chips
- Casting chips, milling chips and sawing chips

Types and main areas of application

KRF 040 – the “classic” scraper conveyor

Pitch of the scraper belt
t = 40 mm

Our standard scraper conveyor for smaller machine tools and small quantities of chips.



KRF 063 – for somewhat “bigger” tasks

Pitch of the scraper belt
t = 63 mm

For larger machines and larger quantities of chips.



KRF 100 – the “Jumbo” for highest demands

Pitch of the scraper belt
t = 100 mm

Special solution for very large quantities of chips.



Standard dimensions

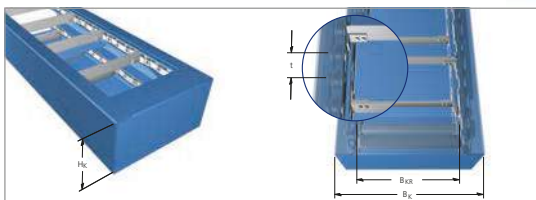

Type	Pitch t	Box height H _K	Scraper belt width B _{KR}	Box width B _K
KRF 040.00	40	140	150, 200, 250, 300, 450, 600	B _{KR} + 90 mm
KRF 063.00	63	216	150, 300, 450, 600, 750, 900	B _{KR} + 120 mm
KRF 100.00	100	420	150, 300, 450, 600, 750, 900	B _{KR} + 150 mm

Special widths on request.

PROCESS MANAGEMENT

Belt conveyors

The all-rounders – also for parts with sharp edges

Our belt conveyors are predominantly used on punch-nibbling machines, for transporting punching scrap and punching trimmings. However, other parts can also be transported, such as waste parts from plastic injection machines. The transport belt of the conveyor is resistant to oil and grease.

Structure

- Housing made of steel plate
- Oil-resistant belt
- Protective motor switch
- Convex return shafts
- Shafts with ball bearings
- Adjustable belt tension

Standard dimensions

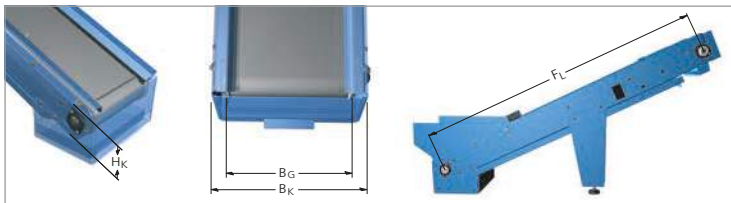

Type	Box height H _K	Belt width B _G	Box width B _K	Maximum conveying length F _L
GBF	104	150, 200, 250, 300, 450, 600	B _G + 50	5000

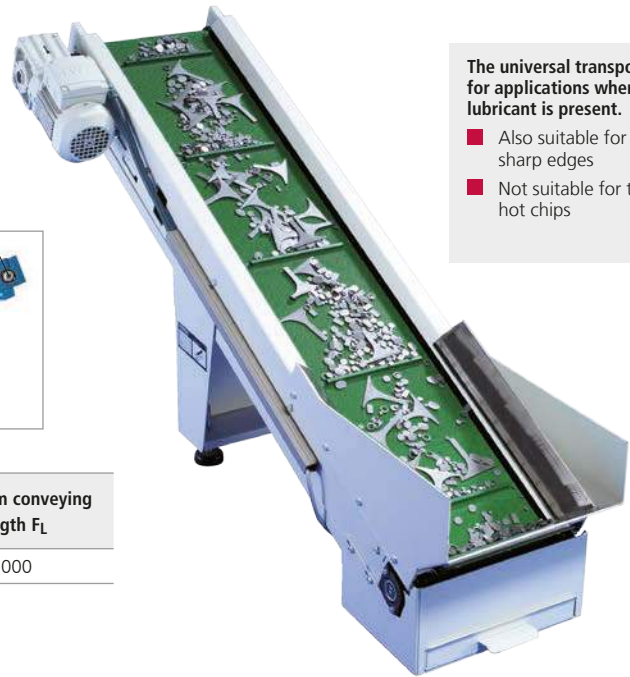

The universal transport solution, for applications where no cooling lubricant is present.

- Also suitable for parts with sharp edges
- Not suitable for transporting hot chips

Modular Conveyors

Hinge belt conveyors in modular design

Using standard assemblies enables us to transfer our production methods to any global production site within the group of companies. Thus, we realize a production nearby and guarantee shortest delivery times. Any time just where you are.

Configurable from standard modules: discharge unit, tank, feeding unit, color according to RAL and several further options.

Our modular system provides numerous opportunities to adapt the conveyor to your individual application.

- Optimum delivery times due to global production
- Cost-effective standard assemblies
- Numerous configuration options
- Replacement of single modules possible due to defined interface
- Concept is extendable
- RAL color at customers' option
- Delivery in operational condition – no onsite installation required
- Reduced downtime by only replacing individual modules

We are happy to configure the most suitable system for you.

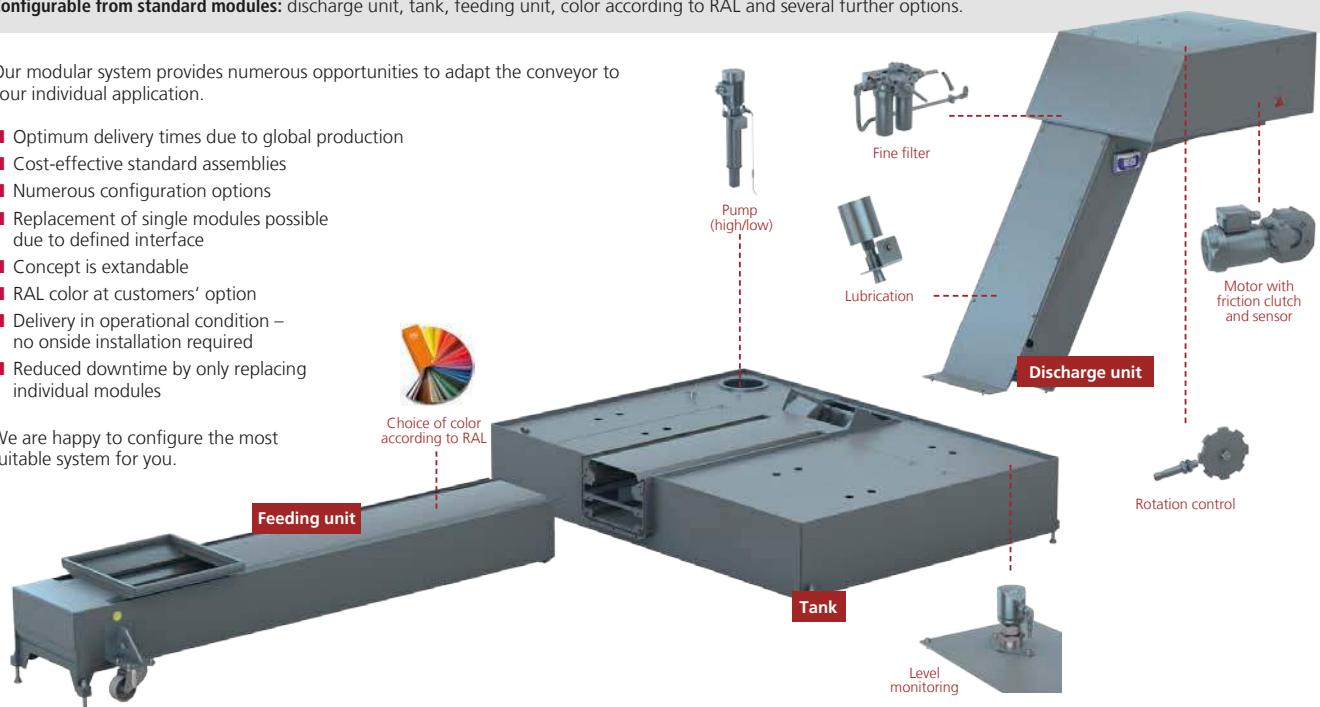

KABELSCHLEPP

Innovative solutions

for the machine tool industry

CABLE CARRIER SYSTEMS

Cable carriers made of steel and plastic
QUANTUM® cable and hose carrier system
PROTUM® cable and hose carrier system
ROBOTRAX® cable and hose carrier system

TRAXLINE® Cables for Motion

Continuous bending hi-flex cables for cable carriers
TOTALTRAX® complete turn-key carrier systems
Pre-assembled cables

Guideway Protection Systems

Telescopic covers
Link apron covers
Way wipers
Conical spring covers
Bellows
Protective devices

Conveyor Systems

Hinged belt conveyors
Scraper conveyors
Belt conveyors



TSUBAKI KABELSCHLEPP GmbH

Daimlerstraße 2
D-57482 Wenden-Gerlingen
Fon: +49 (0)2762 4003-0
Fax: +49 (0)2762 4003-220
E-mail: info@kabelschlepp.de
kabelschlepp.de

KABELSCHLEPP GmbH – Hünsborn

Wielandstraße 1
D-57482 Wenden-Hünsborn
Fon: +49 (0)2762 9742-0
Fax: +49 (0)2762 9742-699
E-mail: ksh@kabelschlepp.de
kabelschlepp.de



TSUBAKIMOTO CHAIN COMPANY

1-1-3 Kannabidai
Kyotanabe, Kyoto 610-0380, Japan
Fon: +81 (0)774 64-5023
Fax: +81 (0)774 64-5212
E-mail: info@tsubakimoto.com
tsubakimoto.com

TSUBAKI KABELSCHLEPP worldwide

For contacts and addresses visit our
web site at kabelschlepp.de/salesnetwork