

TSUBAKI

Smart Series Replaceable Tooth Insert

Large Size Conveyor Chain Sprockets

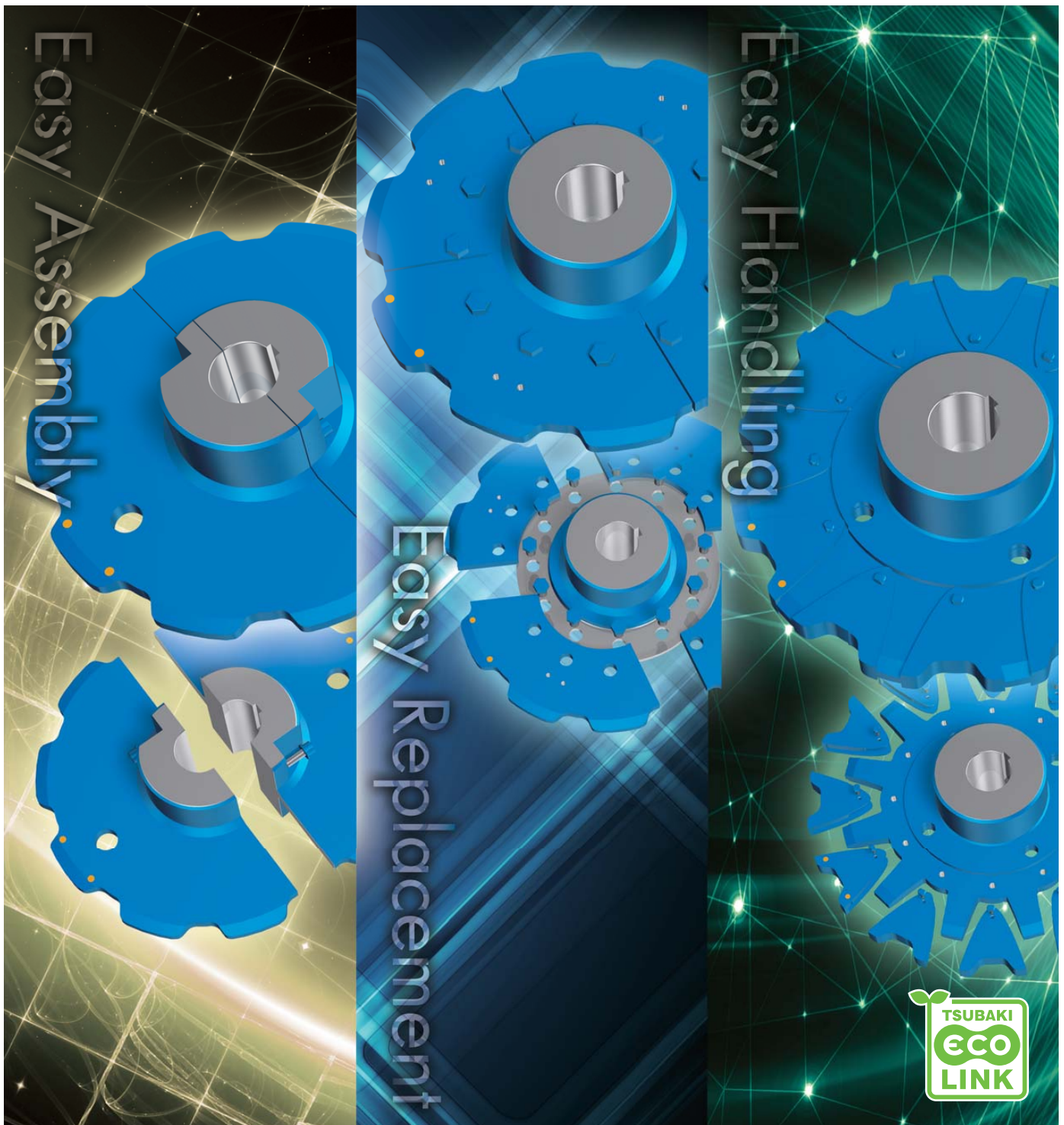

Smart Series Replaceable Tooth Insert Large Size Conveyor Chain Sprockets

Sprocket replacement takes a lot of time and labor, and sometimes requires the shaft to be cut. And work in high places is especially dangerous, and takes even more time. Tsubaki's Smart Series Replaceable Tooth Insert Series of sprockets is the solution to these problems. Tsubaki offers three types (split type, ring insert tooth type, and block insert tooth type) to reduce your replacement and labor time.

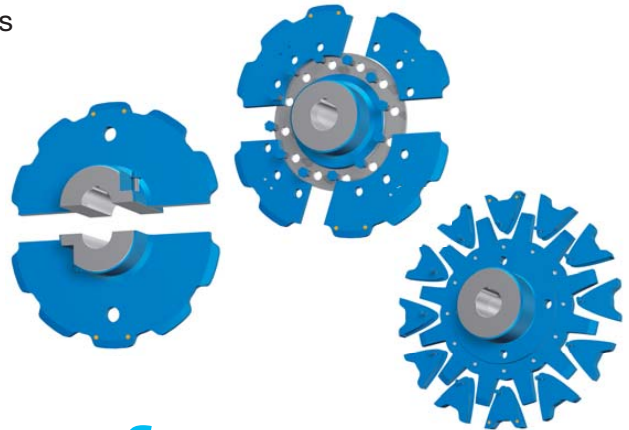

Three smart features

1 **Just the teeth can be replaced**
without having to remove the sprocket from the shaft

2 **Indicator pins**
let you know when to replace your sprockets

3 **All three types**
can be used in a wide range of operating environments

Sample graph showing running costs of new sprockets

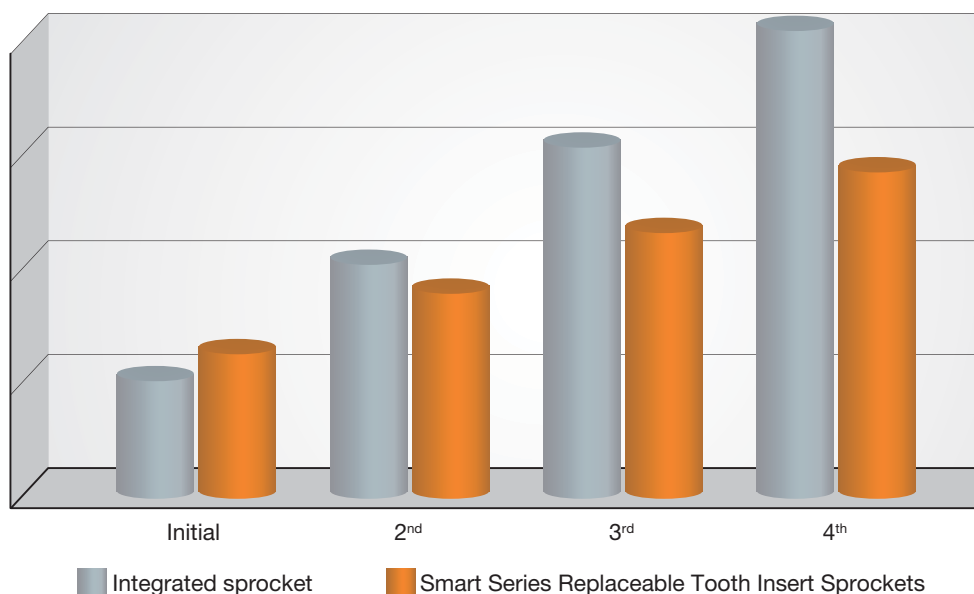

*The Smart Series can be replaced without attaching or removing bearings or other parts, which reduces your running costs.

Indicator pins

Lets you know when to replace your sprockets with just a glance.

Previous inspections

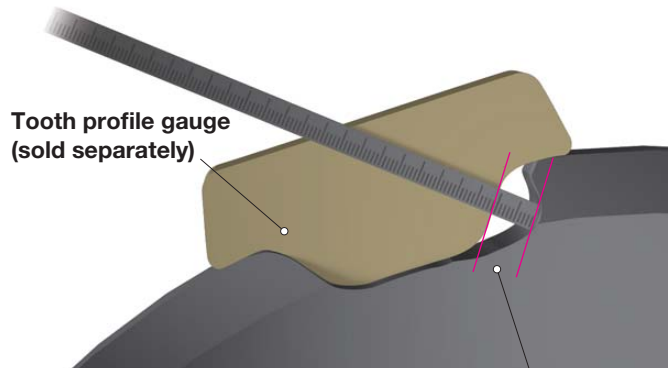

Tooth profile gauge
(sold separately)

Measures the gap between the worn tooth and the tooth profile gauge

Inspection using indicator pins

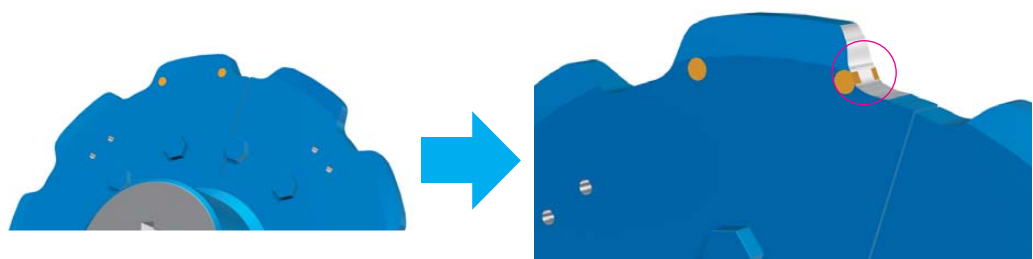

The sprocket has reached its usage limit when tooth wear reaches the indicator pins (prepare for replacement as wear gets closer).

Features

- Enables users to greatly reduce inspection time and labor.
- Users can confirm replacement periods with just a glance, making inspections smooth and easy.
- Lets you know when it's replacement time without needing to use tooth profile gauges or other specialty tools.

Specifications

- Embedded brass pin specifications
- Embedded in both sides of two sprocket teeth at 0° and 180°. When shaft holes are finished, indicator pins will be embedded in the tooth above the keyway.
- Sprockets are coated blue to make indicator pin confirmation easy.

Smart Series Replaceable Tooth Insert Large Size Conveyor Chain Sprockets

Type	Split Type	Ring Replaceable Tooth Type	Block Replaceable Tooth Type
Features	<ul style="list-style-type: none"> ● Sprockets divided into halves without any gaps around the shaft bore. ● Can be mounted by fastening hub bolts. ● Split Sprockets can be replaced without having to remove other parts. ● Available for all types of rollers. 	<ul style="list-style-type: none"> ● Lock ring type replaceable teeth with bolts/nuts onto the mounting base. ● Just the teeth can be replaced without having to remove the mounting base from the shaft. ● Available for all types of rollers. 	<ul style="list-style-type: none"> ● Lock block type replaceable teeth with bolts/nuts onto the mounting base. ● Just the teeth can be replaced without having to remove the Block Replaceable Tooth from the shaft. ● The lightest mass per replaceable tooth, with easy handling.
Available for	RF03075 ~ RF10150	RF10150 ~ RF36300	RF10150 ~ RF26300
	RF205 ~ RF650 (imperial sizes)	RF6205 (imperial sizes)	—
Roller type*	S , R, F	S , R, F	S
No. of teeth	6, 8, 10 , 12	8, 10 , 12	10 , 12
Tooth material	Carbon steel for machine structural use		Alloy steel for machine structural use
Hub (mounting base) material	Roller steel for general structural use		
Coating	Lacquer coating (blue)		

*Items not in bold may not be available.

*M and N rollers are also available.

Other specifications available, contact a Tsubaki representative for more information.

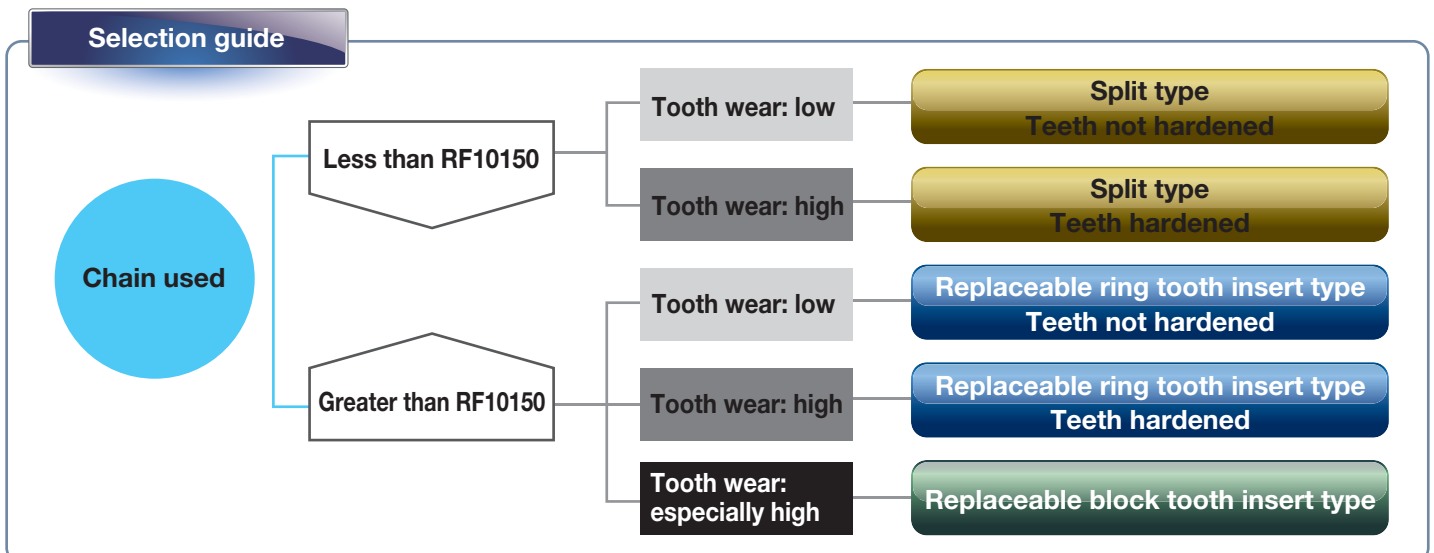

Applications

- When wear causes high replacement frequency
- When sprockets are difficult to remove from their shaft due to attachment of conveyed material, corrosion, etc.
- When there is little space for replacement
- When the sprocket is located in a high place
- When using several sprockets on a long shaft



Smart Series Replaceable Tooth Insert Sprockets demonstrate their usefulness when used on these types of equipment



Bucket elevator
Used in high places

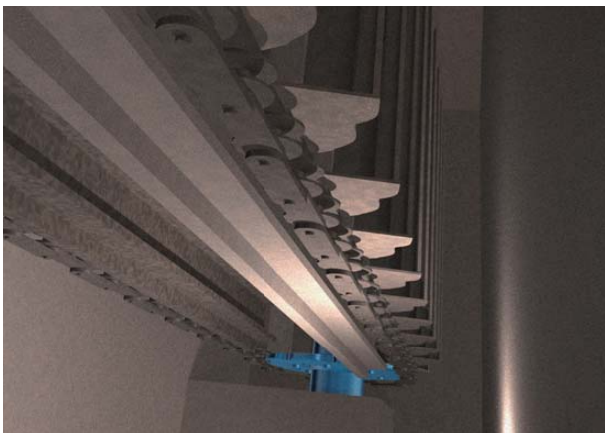

Slag conveyor
Little space for replacement

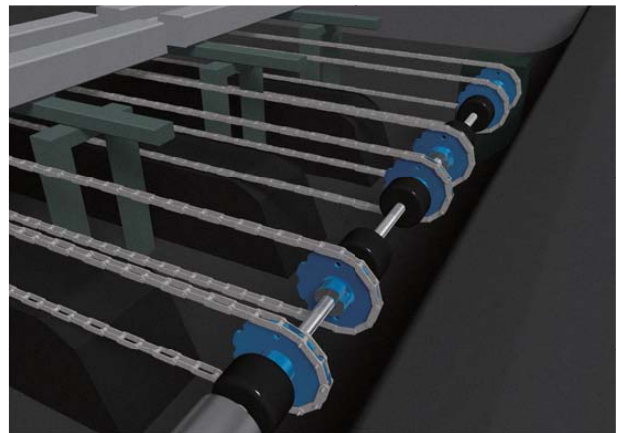

Steel girder conveyor
Sectional replacement on long shafts

Shaft assembly service

- Tsubaki manufactures the shafts and delivers them assembled together with the sprocket.
- No need to mount the sprocket to the shaft, which can reduce equipment mounting labor.
- For Smart Series Replaceable Tooth Insert Sprockets especially, with your next replacement you can generally replace just the split sprocket or teeth.

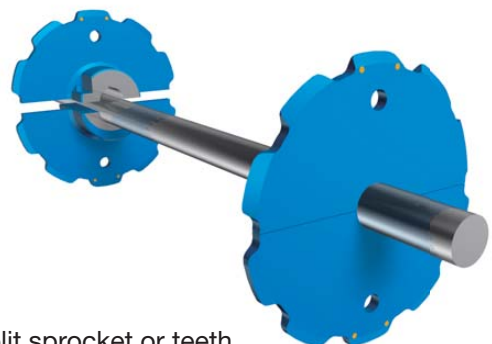

Split type

Sprockets are split in two (teeth and hub) for easy replacement

Construction

- Sprockets are split in two through the tooth roots.
(Halves can also be joined together with nuts and bolts.)

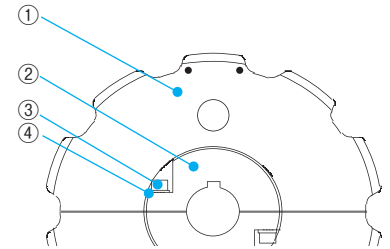
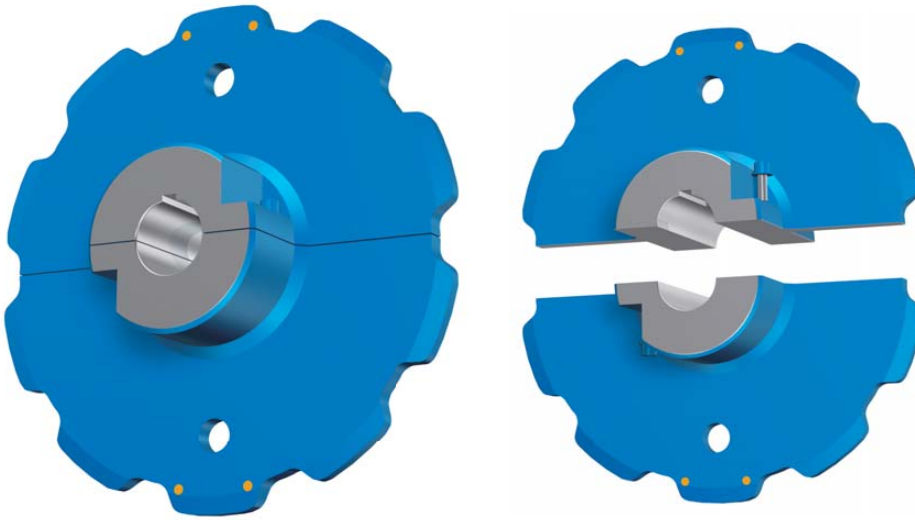

- ①Teeth
- ②Hub (welded to (1) teeth)
- ③Bolt
- ④Spring washer

Features

- Sprockets can be mounted and removed to the shafts without needing to remove bearings first.
- Useful in situations where mounting or removing the sprocket from long shafts is difficult.

Model numbering

RF10150S 10T - BW Q - S TS - E

①Chain no. ②No. of teeth ③Hub type ④Hardened teeth ⑤Smart Series ⑥Split type ⑦Indicator pins

BW: Welded single side N: Teeth not hardened
CW: Welded both sides Q: Teeth hardened

(Note) Split type sprockets come with finished bores. Indicate bore finishing instructions separately.

Price/delivery

Made-to-order item

Ring Type Replaceable Tooth Insert Sprockets

Ring type replaceable tooth inserts for easy replacement

Construction

■ Composed of replaceable piece-like tooth inserts, a mounting base (sprocket hub), and bolts, spring washers, and nuts.

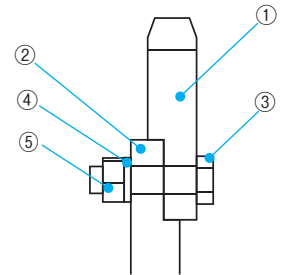
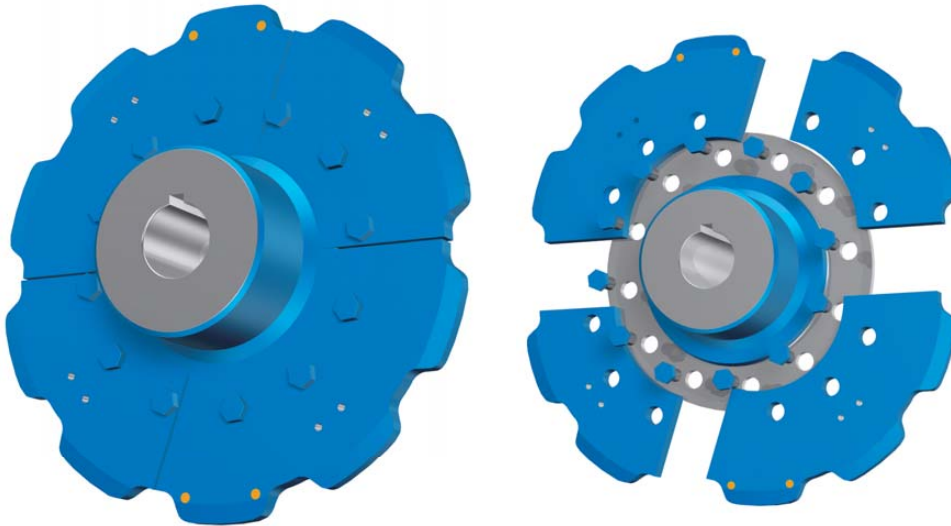

- ① Tooth insert
- ② Mounting base
- ③ Bolt
- ④ Spring washer
- ⑤ Nut

Features

- Just the tooth inserts can be replaced without removing the mounting base from the shaft.
- Useful when replacing sprockets in high places.

Model numbering

RF26300S 10T - BW1 Q - S RK - E

① Chain no. ② No. of teeth ③ Hub type ④ Hardened teeth ⑤ Smart Series ⑥ Ring type ⑦ Indicator pins

BW1: Welded single side N: Teeth not hardened
 CW1: Welded both sides Q: Teeth hardened

*Tooth insert model numbers (for when replacing tooth inserts only)

RF26300S 10T - RE Q - S RK - E

Tooth inserts

(One tooth insert, bolts, spring washers, and nuts for one sprocket come as a set.)

Note: A drawing number is required when initially providing special specifications. Indicate the drawing number on your order form.

Price/Delivery

Made-to-order item

List of models/dimensions

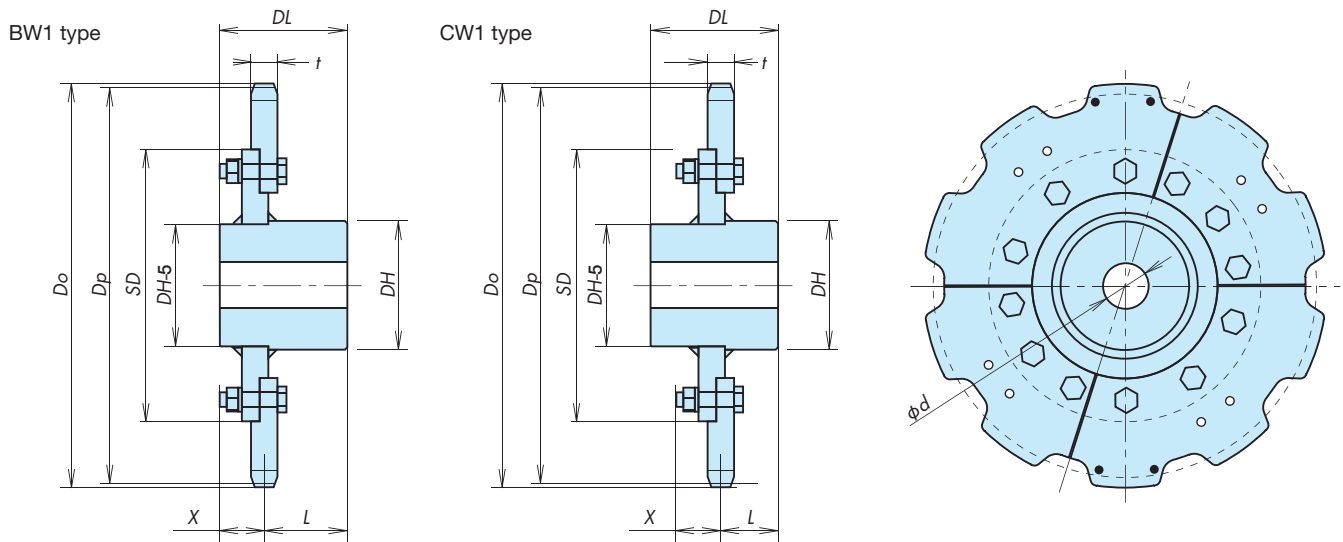

Model no.	No. of teeth	Pitch Circle Dia. Dp	Outer Dia. Do		Bore Dia.		Tooth Width t			Hub Dia. DH	Total Length DL	Center Distance L	Mounting Base OD SD	Mounting Bolt Size	Bolt Protrusion X	No. of Tooth Inserts	Hanging Tap Size	Approx. Mass per Tooth Insert kg	Total Approx. Mass kg
			R	F	S	Pilot Bore d	Max. dmax.	R	F										
RF10150□10T-□□-SRK-E	10	485.4	507	503	38	110	22	16	22	157	158	122	305	M16	44	2	M8	12	54
RF10150□12T-□□-SRK-E	12	579.6	601	597	38	115	22	16	22	167	169	133	405	M16	44	3	M8	10	73
RF12200□8T-□□-SRK-E	8	522.6	551	544	60	120	28	19	28	177	175	125	330	M16	51	2	M8	17	75
RF12200□10T-□□-SRK-E	10	647.2	682	668	65	130	28	19	28	187	185	135	460	M16	51	2	M8	22	106
RF12200□12T-□□-SRK-E	12	772.7	811	794	75	145	28	19	28	207	205	155	590	M16	51	3	M10	18	148
RF12250□8T-□□-SRK-E	8	653.3	680	688	65	130	28	19	28	187	185	135	450	M16	51	2	M8	24	107
RF12250□10T-□□-SRK-E	10	809.0	841	830	75	145	28	19	28	207	205	155	615	M16	51	2	M10	30	159
RF12250□12T-□□-SRK-E	12	965.9	1002	987	80	160	28	19	28	227	225	175	780	M16	51	3	M10	24	222
RF17200□10T-□□-SRK-E	10	647.2	691	671	75	145	40	28	40	207	205	148	450	M20	65	2	M10	34	147
RF17200□12T-□□-SRK-E	12	772.7	821	797	80	160	40	28	40	227	225	168	580	M20	65	3	M10	28	207
RF17250□8T-□□-SRK-E	8	653.3	689	677	75	145	40	28	40	207	205	148	400	M20	65	2	M10	39	148
RF17250□10T-□□-SRK-E	10	809.0	851	833	80	160	40	28	40	227	225	168	565	M20	65	2	M10	51	220
RF17250□12T-□□-SRK-E	12	965.9	1013	990	80	160	40	28	40	227	245	188	730	M20	65	3	M12	41	297
RF17300□8T-□□-SRK-E	8	783.9	816	827	80	160	40	28	40	227	225	168	640	M20	65	2	M10	36	212
RF17300□10T-□□-SRK-E	10	970.8	1010	995	80	160	40	28	40	227	245	188	840	M20	65	2	M12	44	302
RF17300□12T-□□-SRK-E	12	1159.1	1204	1183	85	175	40	28	40	247	265	208	1035	M20	65	3	M16	35	421
RF26200□10T-□□-SRK-E	10	647.2	—	674	80	160	—	—	45	227	225	164	450	M24	72.5	2	M10	40	174
RF26200□12T-□□-SRK-E	12	772.7	—	800	85	175	—	—	45	247	265	204	580	M24	72.5	3	M12	33	250
RF26250□8T-□□-SRK-E	8	653.3	703	680	80	160	45	32	45	227	225	164	400	M24	72.5	2	M10	46	175
RF26250□10T-□□-SRK-E	10	809.0	864	836	85	175	45	32	45	247	265	204	565	M24	72.5	2	M12	60	265
RF26250□12T-□□-SRK-E	12	965.9	1026	993	85	175	45	32	45	247	265	204	730	M24	72.5	3	M16	49	346
RF26300□8T-□□-SRK-E	8	783.9	829	811	85	175	45	32	45	247	265	204	520	M24	72.5	2	M12	60	253
RF26300□10T-□□-SRK-E	10	970.8	1025	998	85	175	45	32	45	247	265	204	720	M24	72.5	4	M16	46	379
RF26300□12T-□□-SRK-E	12	1159.1	1219	1186	95	190	45	32	45	267	295	234	915	M24	72.5	4	M16	46	487
RF36250□10T-□□-SRK-E	10	809.0	—	839	95	190	—	—	55	267	265	198	565	M30	87.5	4	M16	45	348
RF36250□12T-□□-SRK-E	12	965.9	—	996	95	190	—	—	55	267	295	228	730	M30	87.5	4	M16	47	429
RF36300□8T-□□-SRK-E	8	783.9	853	814	95	190	55	36	55	267	265	198	520	M30	87.5	4	M12	38	302
RF36300□10T-□□-SRK-E	10	970.8	1046	1001	95	190	55	36	55	267	295	228	720	M30	87.5	4	M16	58	471
RF36300□12T-□□-SRK-E	12	1159.1	1234	1190	100	210	55	36	55	297	285	218	915	M30	87.5	4	M16	59	593
RF6205□10T-□□-SRK-E	10	493.2	528	514	60	120	28	19	28	167	175	125	315	M16	51	2	M8	15	67
RF6205□12T-□□-SRK-E	12	588.8	623	610	60	120	28	19	28	177	175	125	415	M16	51	3	M8	13	89

- Note
- Numbers of teeth, hub diameters, and so on not shown in the table above also available. Contact a Tsubaki representative for more information.
 - Check that there is no interference between the tooth outer diameters and buckets, aprons, etc.
 - Check for interference between the bolt protrusion and equipment.
 - There is a gap on the mating area of each type of replaceable tooth.
 - For model numbers, insert roller type (R/F/S), hub type (BW1/CW1, or RE for tooth inserts only), and tooth hardening (Q/N) in the boxes.
 - L is DL/2 with CW1 hubs. The table above shows values for BW1 hubs.
 - Items with a "-" are not available.
 - Approximate masses shown are when used with S rollers. Contact a Tsubaki representative regarding approximate masses when using other rollers.
 - There are two taps for hanging on each tooth insert (each piece). Use for attaching wire ropes or eye bolts.
 - Refer to the handling instructions regarding steps for sprocket mounting and removal.

Block Type Tooth Insert Sprocket

Wear resistant block teeth for easy replacement

Construction

■ Composed of individual tooth inserts, a mounting base (sprocket hub), and nuts and bolts.

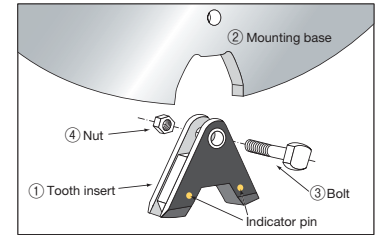
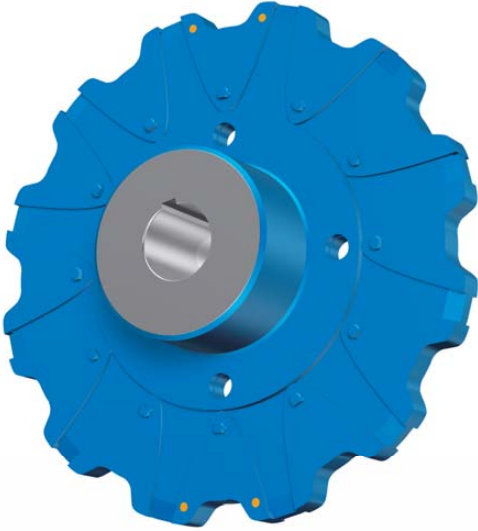

Features

- Just the tooth inserts can be replaced without removing the mounting base from the shaft.
- Tooth inserts use alloy steel standard for high wear resistance.
- Each tooth insert is light.

Model numbering

RF12200S 12T - BW1 Q - S BK - E

① Chain no. ② No. of teeth ③ Hub type ④ Hardened teeth ⑤ Smart Series ⑥ Block type ⑦ Indicator pins

BW1: Welded single side Q: Teeth hardened
CW1: Welded both sides

*Tooth insert model numbers (for when replacing tooth inserts only)

RF12200S 12T - RE Q - S BK - E

Tooth inserts

(One tooth insert, bolts, nuts, and special adhesive for one sprocket come as a set.)

Note: A drawing number is required when initially providing special specifications. Indicate the drawing number on your order form.
We cannot provide a number of tooth inserts that differs from the number of teeth on the mounting base.

Price/Delivery

Made-to-order item

List of models/dimensions

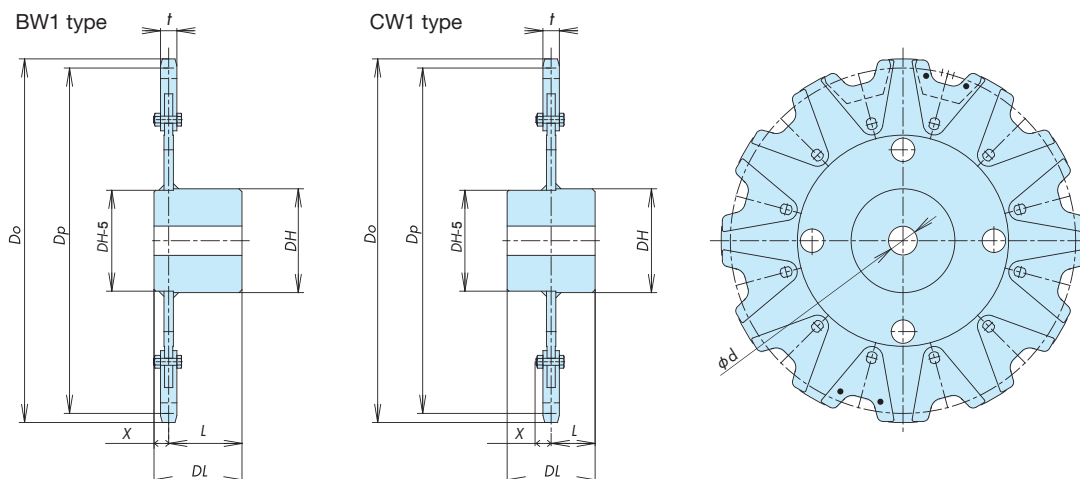

Model no.	No. of teeth	Pitch Circle Dia. D_p	Outer Dia. D_o	Bore Dia.		Tooth Width t	Hub Dia. DH	Total Length DL	Center Distance L		Mounting Bolt Size	Bolt Protrusion X	Approx. Mass per Tooth Insert kg	Total Approx. Mass kg
				Pilot Bore d	Max. $d_{max.}$				BW1	CW1				
RF10150S10T-□Q-SBK-E	10	485.4	512	80	160	22	227	200	175	100	10	19	0.9	75
RF10150S12T-□Q-SBK-E	12	579.6	608	85	175	22	247	220	195	110	10	19	0.9	100
RF6205S10T-□Q-SBK-E	10	493.2	527	85	160	28	227	200	170	100	12	26	1.2	78
RF6205S12T-□Q-SBK-E	12	588.8	620	85	175	28	247	220	190	110	12	26	1.2	111
RF12200S10T-□Q-SBK-E	10	647.2	678	95	190	28	267	240	210	120	12	26	1.2	135
RF12200S12T-□Q-SBK-E	12	772.7	804	100	210	28	297	240	210	120	12	26	1.2	177
RF17200S10T-□Q-SBK-E	10	647.2	680	95	190	40	267	270	235	135	14	24.5	1.7	163
RF17200S12T-□Q-SBK-E	12	772.7	806	100	210	40	297	260	225	130	14	24.5	1.7	207
RF17250S10T-□Q-SBK-E	10	809.0	840	100	210	40	297	260	225	130	14	24.5	1.7	214
RF17250S12T-□Q-SBK-E	12	965.9	996	100	210	40	297	260	225	130	14	24.5	1.7	254
RF26200S10T-□Q-SBK-E	10	647.2	686	100	210	45	297	260	225	130	14	28	2.4	191
RF26200S12T-□Q-SBK-E	12	772.7	810	110	225	45	317	270	235	130	14	28	2.4	240
RF26250S10T-□Q-SBK-E	10	809.0	846	110	225	45	317	270	235	135	14	28	2.4	248
RF26250S12T-□Q-SBK-E	12	965.9	1002	110	225	45	317	270	235	135	14	28	2.4	292
RF26300S10T-□Q-SBK-E	10	970.8	1007	110	225	45	317	270	235	135	14	28	2.4	292
RF26300S12T-□Q-SBK-E	12	1159.1	1195	120	235	45	337	280	245	140	14	28	2.4	379

- Note 1. Numbers of teeth, hub diameters, and so on not shown in the table above also available. Contact a Tsubaki representative for more information.
 2. Contact a Tsubaki representative when your chain uses M or N rollers.
 3. Check that there is no interference between the tooth outer diameters and buckets, aprons, etc.
 4. Check for interference between the bolt protrusion and equipment.
 5. Enter the hub type (BW1, CW1, or RE for tooth inserts only) in the boxes in the model number.
 6. All teeth are hardened.
 7. Refer to the handling instructions regarding steps for sprocket mounting and removal.

1. Common elements of Smart Series Tooth Insert Sprockets

(1) Indicator pins

① Inspection steps

- Remove any material attached to the sprocket profile so that you can check the indicator pins.
- There are two indicator pins (at roughly 0° and 180°) embedded into the teeth of each sprocket.
With two indicator pins on one side of one tooth, there are a total of four teeth with embedded pins on both sides so they can be used regardless of direction of rotation.
- The position of the indicator pins will vary by model (available chain size, sprocket no. of teeth, type).
With finished bores, there will be one indicator pin located on the tooth nearest to the top of the keyway.
- The sprocket has reached its usage limit when wear reaches the indicator pins.

② Points of caution

- Wear will rapidly accelerate if the sprocket continues to be used after wear has reached the indicator pins.
This will also adversely impact the chain. We recommend immediate replacement.
- Replace your sprocket if wear exceeds 20% of tooth width t before reaching the indicator pins.
Review your sprocket's alignment before wear exceeds 20%.



Tooth profile wear and indicator pins

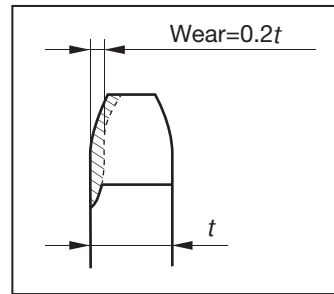

Tooth profile wear

(2) Before mounting and removing

① Points of caution when mounting and removing

- There is a risk of extreme danger if, while replacing the sprocket or tooth inserts, gravitational balance is lost and leads to the shaft rotating or the sprocket/teeth falling off. Always securely support or anchor the sprocket and teeth before starting work. Also, ensure the work location is safe and that there are a sufficient number of people to assist.
- When removing ring and block type tooth insert sprockets, when using a torch to cut or otherwise remove stubborn bolts that will not budge due to the presence of conveyed material or sprocket corrosion, use a file or grinder to remove scratches, conveyed material, etc. from the mounting base seat. The seat of bolts and nuts is an important element of tooth insert sprocket functionality. Place a patch (rod) with a diameter smaller than the bolt against the bolt and strike with a hammer to loosen the bolt.
- For especially heavy sprockets and tooth inserts, use the hanging hole and eyebolt taps provided. Firmly secure any slings or wires used.
- Thoroughly clean where the sprocket will be mounted on the shaft and the split pieces/mounting base of the sprocket. Use a file or grinder to remove any scratches, corrosion, conveyed material, etc. and give it a smooth finish. If these defects are not removed then sprocket or tooth misalignment or play may develop, which will prevent the chain from properly engaging the sprocket, lead to premature chain/sprocket wear and damage, and lead to the sprocket falling off.

② Mounting bolts

- When finally tightening the bolts and nuts, tighten little by little over several turns to ensure a uniform tightening. Finally, securely tighten the bolts and use a torque wrench to confirm tightness. The following table shows torque values.

Bolt size	M10	M12	M16	M20	M24	M30
Tightening torque [N·m]	68	118	289	568	980	1960

2. Steps for mounting and removing sprockets by type and points of caution

(1) Split types

- Take special care to ensure the sprocket does not fall when mounting or removing. (See pg. 11 before starting.)
When mounting or removing, ensure there are enough people to support the sprocket, tighten the bolts, and perform other work.
- Thoroughly clean the shaft where the sprocket will be mounted and the split sections of the sprocket itself.
- Match the split sprocket to where it is to be mounted on the shaft. When doing so, ensure the alignment marks on the teeth are aligned.
- When matching the split sprocket, there is no gap in the hub assembly surface but there is a gap in the tooth assembly surface. These parts have been designed this way. There will be no problems due to this when the chain engages the sprocket.
- Use the accompanying spring washers and alternate tightening the bolts with a torque wrench to ensure a secure, uniform tightening.
(See pg. 11 before starting.)
- Ensure there is no misalignment of the split sprocket faces when mounting to the shaft.
- The split sprocket will not loosen in normal environments as long as the appropriate torque has been used. In situations where heavy vibrations may cause the sprocket to fall and cause injury, use a thread locking fluid or take other measures to prevent loosening.
- When removing the sprocket, alternate loosening the bolts uniformly. Before loosening the bolts, reconfirm the sprocket is securely supported or anchored so that no piece can fall.
(See pg. 11 before starting.)

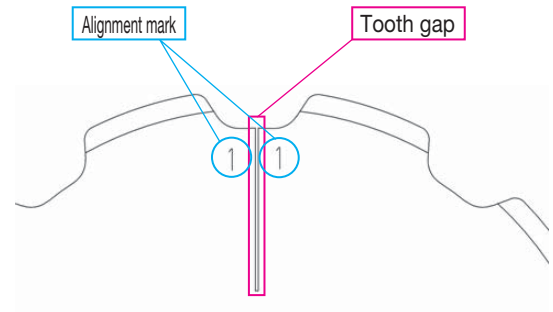

(2) Ring type split sprockets

- Take special care to ensure the sprocket or tooth inserts do not fall when mounting or removing.
(See pg. 11 before starting.)
When replacing tooth inserts, ensure there are enough people to support the tooth inserts, tighten the bolts and nuts, and perform other work.
- Thoroughly clean the shaft where the sprocket will be mounted and the mounting base.
- Ensure the alignment marks on the tooth inserts are aligned and temporarily tighten the bolts, spring washers, and nuts.
- Adjust the inserts so that the mounting gap is uniform. The gap should be between 1 - 3 mm. There will be no problems due to this when the chain engages the sprocket.
- Adjust so that the heights of the tooth insert bottoms are uniform with the heights of adjacent tooth inserts.

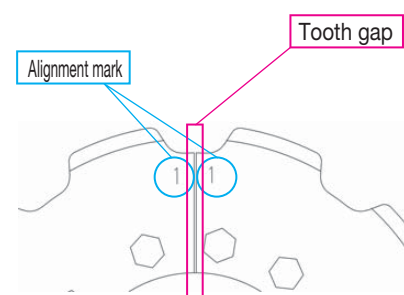

Usage

- Spot weld all nuts in two places to prevent loosening. The sprocket is designed for use in harsh environments with vibration, impact, and corrosion. These factors are envisioned to make it easy for nuts and bolts to loosen. Securely prevent this loosening by spot welding all nuts.

- When removing tooth inserts, use a grinder to remove the spot welds.
- Each tooth insert comes with nuts and bolts attached. Loosen the nuts first. Before loosening the nuts, reconfirm the tooth insert is securely supported or anchored so that no tooth insert can fall. (See pg. 11 before starting.)

- Remove the bolts to remove the tooth inserts. When using a torch to cut or otherwise remove stubborn nuts that will not budge due to the presence of conveyed material or sprocket corrosion, use a file or grinder to remove scratches, conveyed material, etc. from the mounting base seat. (See pg. 11 before starting.)

- Do the same with the remaining tooth inserts to remove them.

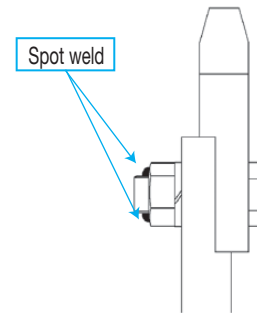

(3) Block type tooth insert sprockets

- Take special care to ensure the sprocket or tooth inserts do not fall when mounting or removing. (See pg. 11 before starting.)

- When replacing tooth inserts, ensure there are enough people to support the tooth inserts, tighten the bolts and nuts, and perform other work.
- Thoroughly clean the shaft where the sprocket will be mounted and the mounting base, and degrease the mounting base and where the new tooth insert will be mounted.
- Use a spatula to apply a coat of special adhesive to the entire surface where the tooth insert will be mounted.
- When attaching the tooth insert to the mounting base, ensure that the bottom of the mounting base and the tooth insert touch.
- Tighten the accompanying nuts and bolts once you are sure they are touching.

When using block type tooth insert sprockets with bucket elevators, attach bolts from the inner side of the conveyor to the outer side.

- Use spot welding on all nuts to prevent loosening.
- Leave for 24 hours to allow the adhesive to dry.

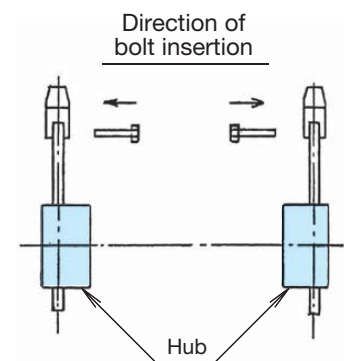
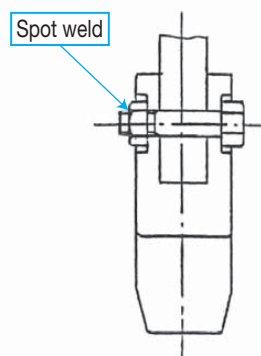
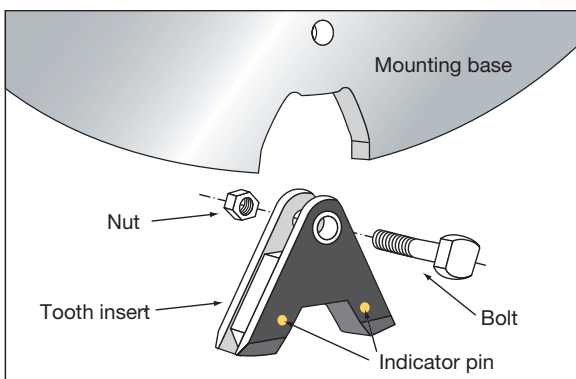

- When removing the nuts, grinder to remove the spot welds, and then loosen the nut to remove. Before loosening the nuts, reconfirm that the tooth insert is securely supported or anchored so that it will not fall when the nut is loosened. (See pg. 11 before starting.)
- When using a torch to cut or otherwise remove stubborn nuts that will not budge due to the presence of conveyed material or sprocket corrosion, use a file or grinder to remove scratches, conveyed material, etc. from the mounting base seat. (See pg. 11 before starting.)
- Remove the bolts to remove the tooth inserts. Be careful when doing so that the tooth insert does not suddenly come off and fall.

Safety Precautions



[WARNING] Observe the items below to prevent danger.

Be sure to read the operation manual before using or adding the product and always use the product correctly.

- When using the sprockets in a lifting device, set up a safety barrier and do not allow anyone to go under the equipment.
- Always install safety equipment (safety covers, etc.) on sprockets and chain.
- Implement safety measures for the equipment in advance and regularly perform maintenance and inspections.
- Follow all applicable local safety regulations as required.
- Observe the following when installing, removing, maintaining, or inspecting the product:
 - Read and follow the instructions in the operation manuals and catalogs before conducting the work.
 - Turn off the instructions in the operation manuals and catalogs before conducting the work and take preventive measures so that the switch will not be turned on unexpectedly.
 - Secure the sprockets and chain to prevent them from moving freely.
 - If a load is always imposed on the equipment (e.g., hoisting equipment), eliminate the load before performing maintenance and inspection work.
 - Wear suitable clothes and protective gear (e.g., safety glasses, gloves, and shoes) when working.
 - Only experienced personnel should perform sprockets replacement.



[CAUTION] Observe the items below to prevent accidents.

- Understand the specifications of the sprockets that you are handling.
- Before installing or replacing sprockets, inspect it to make sure no damage occurred during delivery.
- Inspect and maintain sprockets and chain at regular intervals.
- The product is provided with an operation manual. Be sure to read the operation manual before using the product and always use the product correctly.
 - If the operation manual is not on hand, request an operation manual from your dealer or Tsubaki dealer.

Warranty

1. Warranty period without charge

Tsubakimoto Sprocket Co. (hereinafter referred to as "Company") provides a warranty without charge valid for either 18 months after the shipment of the purchased product (hereinafter referred to as "Goods") from the factory, or 12 months after the first use of Goods, whichever comes first. First use of Goods is considered to be the complete incorporation of Goods into the equipment of the purchasing party (hereinafter referred to as "Customer"). This warranty may be provided with charge in certain circumstances.

2. Warranty coverage

Should any malfunction in Goods arise during the warranty period, given that Goods were properly installed, operated, and maintained as instructed in the catalog, instruction manual, or similar, Company shall promptly deliver or repair Goods or the failed part at no charge once Company has confirmed such failure. This warranty only covers delivered Goods and therefore does not include the following: ("Instruction manual or similar" includes documentation specially provided to Customer.)

- (1) Any costs required for the removal or mounting of Goods from or into Customer's equipment for repair or replacement.
- (2) Costs required for transporting Customer's equipment to repair shop, etc.
- (3) Profits lost due to a malfunction or repair, or any other consequential loss.

3. Warranty with charge

Company will charge for any investigation and repair of a malfunction in Goods (even during the warranty period) if caused by:

- (1) Improper location, installation, lubrication, or maintenance by Customer's failing to follow the catalog, instruction manual, or similar. ("Instruction manual or similar" includes documentation specially provided to Customer.)
- (2) Operation methods (including usage conditions, usage environment, and allowable values) resulting from Customer's failure to follow operation described in the catalog, instruction manual, or similar. ("Instruction manual or similar" includes documentation specially provided to Customer.)
- (3) Inappropriate disassembly, modification, alteration, or processing by Customer.
- (4) Use of Goods by Customer in conjunction with damaged or worn parts not made by Company.
- (5) Failure of operational life under conditions of use as determined by Company to satisfy operational life covered by Warranty.
- (6) Use by Customer under conditions other than those discussed.
- (7) Consumption, wear, or deterioration of bearings, oil seals, oil, and other consumable parts incorporated into Goods.
- (8) Secondary failure or malfunction resulting from malfunctioning of Customer's equipment.
- (9) Malfunction of Goods resulting from a Force Majeure such as an act of God.
- (10) Malfunction of Goods resulting from a wrongful act committed by a third party.
- (11) Any other reason that is not attributable to Company.



CAUTION

Product details described in this catalog are primarily intended to aid product selection. Always read the instruction manual before using any product to ensure correct use.

The logos and product names appearing in this catalog are the trademarks and registered trademarks both in Japan and other countries of Tsubakimoto Chain Co. and affiliated Group Companies.



TSUBAKIMOTO CHAIN CO.

Japan

Tsubakimoto Chain Co.

<https://tsubakimoto.com/>

Global Group Companies

AMERICAS

United States

U.S. Tsubaki Power Transmission, LLC

<https://www.ustsubaki.com/>

Brazil

Tsubaki Brasil Equipamentos Industriais Ltda.

<https://tsubaki.ind.br/>

Canada

Tsubaki of Canada Limited

<https://tsubaki.ca/>

EUROPE

Netherlands

Tsubakimoto Europe B.V.

<https://tsubaki.eu/>

France

Kabelschlepp France S.A.R.L.

<https://tsubaki-kabelschlepp.com/fr-fr/>

Germany

Tsubaki Deutschland GmbH

<https://tsubaki.de/>

Tsubaki Kabelschlepp GmbH

<https://tsubaki-kabelschlepp.com/de-de/>

Italy

Kabelschlepp Italia S.R.L.

<https://tsubaki-kabelschlepp.com/it-it/>

Spain

Tsubaki Ibérica Power Transmission S.L.

<https://tsubaki.es/>

United Kingdom

Tsubakimoto UK Ltd.

<https://tsubaki.eu/>

Slovakia

Kabelschlepp-Systemtechnik, spol. s.r.o.

<https://tsubaki-kabelschlepp.com/sk-sk/>

Poland

Kabelschlepp Sp. z o.o.

<https://kabelschlepp.pl/>

INDIAN OCEAN RIM

Singapore

Tsubakimoto Singapore Pte. Ltd.

<https://tsubaki.sg/>

Australia

Tsubaki Australia Pty. Limited

<https://tsubaki.com.au/>

India

Tsubaki India Power Transmission Private Limited

<https://en.tsubaki.in/>

Indonesia

PT. Tsubaki Indonesia Trading

<https://tsubaki.id/>

Malaysia

Tsubaki Power Transmission (Malaysia) Sdn. Bhd.

<https://en.tsubaki.my/>

New Zealand

Tsubaki Australia Pty. Limited - New Zealand Branch

<https://tsubaki.com.au/>

Philippines

Tsubakimoto Philippines Corporation

<https://en.tsubaki.ph/>

Thailand

Tsubakimoto (Thailand) Co., Ltd.

<https://tsubaki.co.th/>

Vietnam

Tsubakimoto Vietnam Co., Ltd.

<https://tsubaki.net.vn/>

EAST ASIA

Republic of Korea

Tsubakimoto Korea Co., Ltd.

<https://tsubakimoto-tck.co.kr/>

Taiwan

Taiwan Tsubakimoto Trading Co., Ltd.

<https://tsubakimoto.tw/>

CHINA

China

Tsubakimoto Chain (Shanghai) Co., Ltd.

<https://www.tsubaki-sh.cn/>



The Tsubaki Eco Link logo is used only on products that satisfy the standards for environmental friendliness set by the Tsubaki Group.